

---

BAND SAW

**JLH-33**

INSTRUCTION MANUAL

**B-33**

---

---

、

Thank you for your choice of our products and it is our honor that you become our user.  
Before you start to use your new machine please read the instruction manual carefully to  
Enjoy safe using and a longer life service.

The complete instruction manual consists of the following parts.

- Safety Guidance
- Machine Overview
- Instruction Manual

Due to the continuous improvements, there will be difference between the product descriptions  
In the manual and the actual details of the delivered machine. Please kindly understand and  
The correct specification is subject to the delivered goods without further notice.

---

# 1、 Safety Guidance

---

Please do not perform any installation, maintenance or adjustment of the machine without reading

The Instruction Manual carefully and accepting complete training.

Please use the band sawing machine only after when you are familiar with the characteristics of the machine, safety information and all related guidelines.

## 1.1 Unpacking\Lifting



- Wrongdoing in lifting may result in personal injury.
- Pay attention to the barycenter to avoid incline, otherwise dangers or death may occur.



- Do not move or stand under the machine when lifting.



- Take care of the box board and nails or other things to avoid to occurring dangers.
- Avoid to overturn the machine, otherwise dangers may occur.

# 1、 Safety Guidance

---

## 1.2 Installation

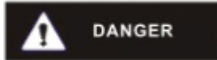

- Improper level of the packing block under the machine could cause personal injury.
- Always have good grounding installation to ensure personal safety.



- Never operate the machine before adjusting process is completed.
- Do not clean the machine with gasoline and other flammable liquids.



- User must follow power parameter indicated in the instruction book in fear of damage the machine.
- User must set the fuse in the power switch as pre-insurance unit.

## 1.3 Testing



- Must read guidance carefully and understood well before testing and prohibit improper operation, otherwise occur dangers.
- Must fix workpiece on the working platform tightly, otherwise occur dangers.



- Never to operate machine without training.
- Must stop machine immediately when these is abnormal sound, and identify the reason and rule out it.



- Operator must be in good health condition when operating the machine.

## 1.4 Operation

# 1、 Safety Guidance

---

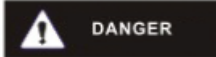

- Do not touch the blade, workpiece and chips when the machine is running.
- Do not check and/or repair the machine when the machine is running.
- Must fix the workpiece on the work platform tightly.



- Do not wear gloves when operating.
- Do not work in excess of the machine cutting conditions (Max. Torque. Max. Cutting Resistance. Large Power).
- Prohibition of non-operator in the workplace.
- Do not move, install and measuring the workpiece if it is not in security state when the machine stopped.
- Do not change the speed when the machine is running.



- Must to turn off the power switch when a sudden power failure, otherwise there are dangers when the machine running suddenly in which case the power supply suddenly again.

## 1.5 Maintenance

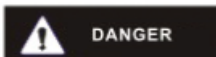

- Prohibition of disassembling and/or assembling on the impact of machine performance and safety.
- Non-professional can not carry out related maintenance.



- Maintenance should be carried out under power off, otherwise occur dangers.



- Please read the chapter of maintenance in the Instruction Manual.

### 3、 Installation and Adjustment

---

#### 2.1 Front View

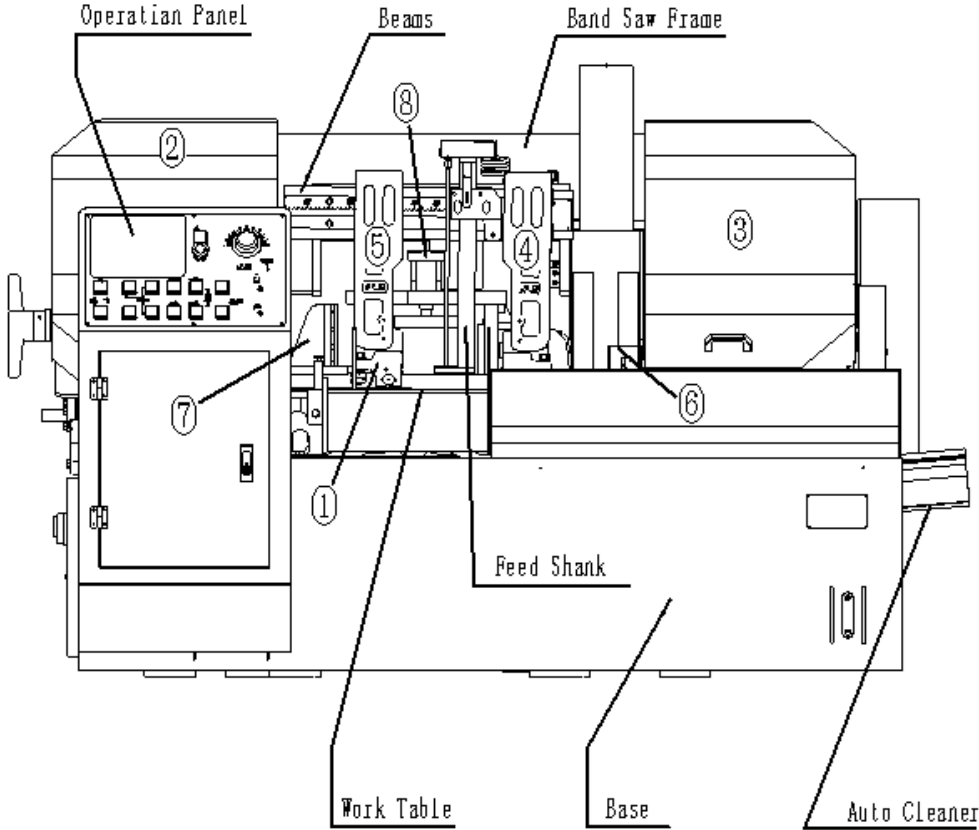

- |   |                             |   |                  |
|---|-----------------------------|---|------------------|
| 1 | Tungsten steel holder block | 5 | Guide Arm        |
| 2 | Passive Wheel Cover         | 6 | Belt Wheel Cover |
| 3 | Active Wheel Cover          | 7 | Activities Clamp |
| 4 | Fixed Guide Arm             | 8 | Upper Clamp      |

### 3、 Installation and Adjustment

---

#### 2.2 Left View

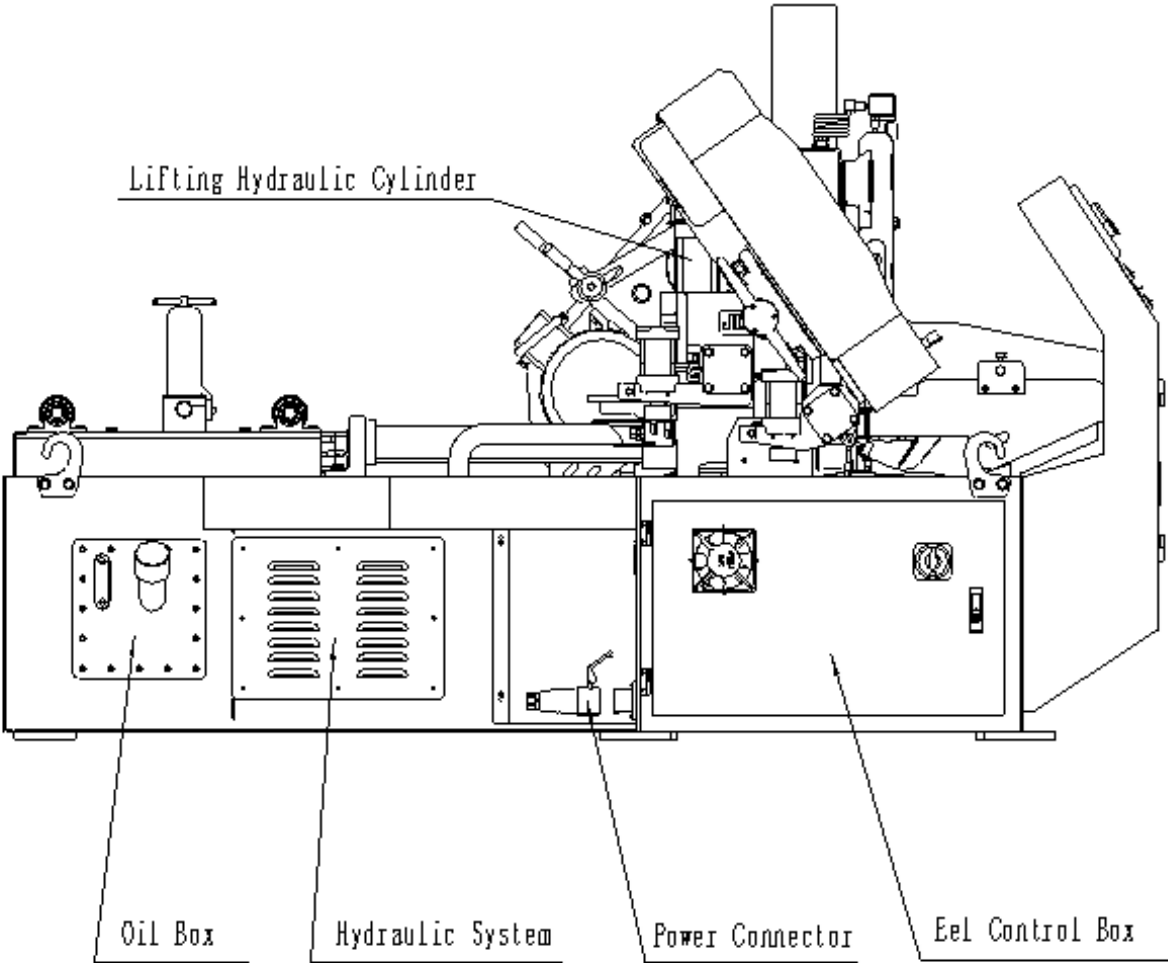

### 3、 Installation and Adjustment

---

#### 2.3 Up View

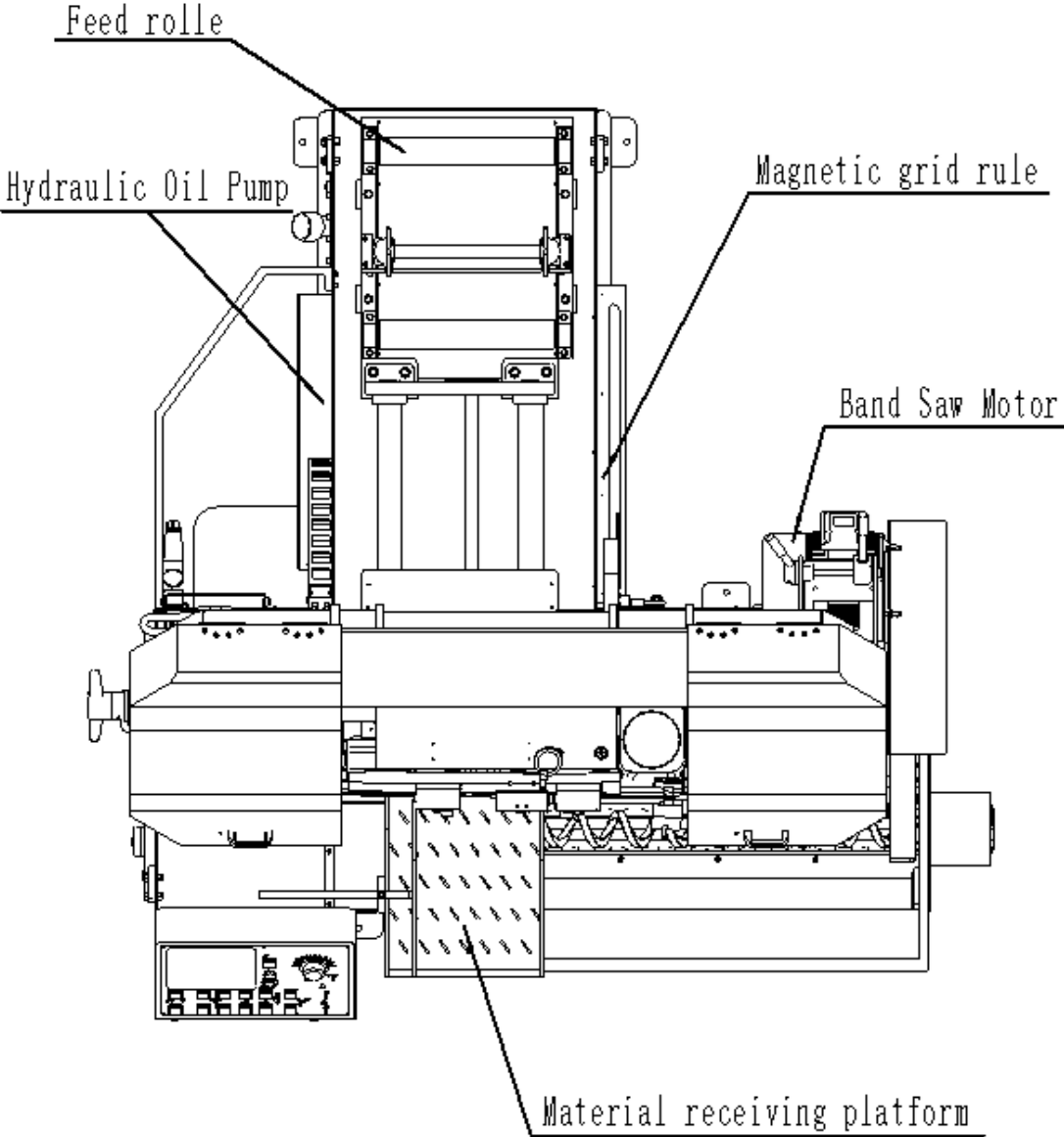



### 3、 Installation and Adjustment

#### 2.4 Specification

Model		B33
Single Capacity(in/mm)		Φ 13 ■ 13 (W) × 13 (H) Φ 330 ■ 300 (W) × 300 (H)
bundle cutting (in/mm)		13 (W) × 4-3/4 (H) 300 (W) × 120 (H)
Single material Header Length(in/mm)		140 (10mm 吋) 5-1/2 (25/64in, 10mm 吋)
Band Saw Speed (ft/min) (m/min)		20~140 65~460
One Sending Length(in/mm)		500 19-5/8
Repeat positioning accuracy (mm)		±0.1
Band Saw Size(in/mm)		162 (L) × 1-1/2 (W) × 0.0042 (T) 4115 (L) × 34 (W) × 1.1 (T)
Band Saw Tension		hydraulic
(hp/kw) Motor	Band Saw Motor	5/4
	Hydraulic Motor	1/0.75
	Cooling Motor	0.16/0.12
Tank Capacity	Hydraulic Oil (L)	72
	Cutting liquid(L)	120
Weight (LB/KG)		3520

#### 2.5 Pressure Set and Data

Model		B33
Pressure Category		
Pressure of Hydraulic(bar)		38±2
Band Saw Tension(100bar)		22±2

## 3、 Installation and Adjustment

---

### 3.1 Transit and Lifting

#### 3.1.1 Forklift handling

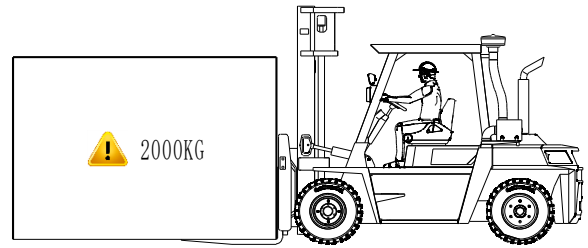
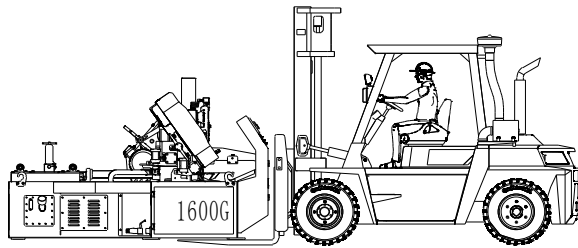

#### 3.1.2 Lifting

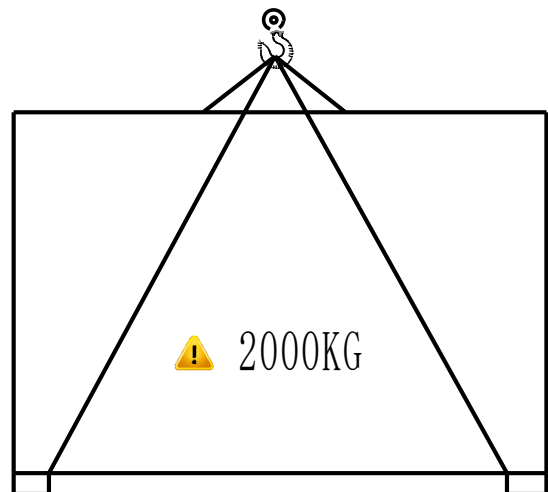
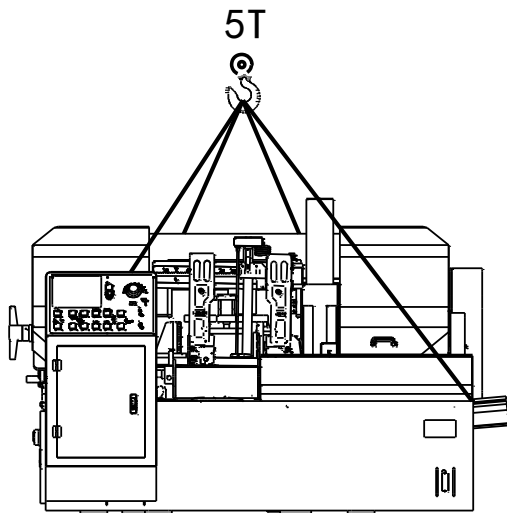

- Sling must can bear twice weight of machine. Must focus lifting balance and around safe.



- Place the soft cushion between the machine and sling to protecting damage paint of machine.

## 3、 Installation and Adjustment

---

### 3.2 Cleaning

Paint anti-rust oil on the surface of the machine, must clean it with kerosene or other Cleaning agent after placing the machine.



- No use gasoline or other corrosive cleaning agent to cleaning the machine, to preventing fire.

### 3.3 Placing

There should be enough space to move workpiece.

;

When doing maintenance, make sure all the protection gate and/or the distributor will not intervene when opened.

Fixer of machine to protect the saw frame and to facilitate the transport, so please keep it carefully or use of moving machine.

### 3、 Installation and Adjustment

---

#### 3.4 Horizontal Adjustment

Adjust the level with the spirit level along the guide of work table according to the Instruction manual after placing the machine, and then fix the foot bolt.

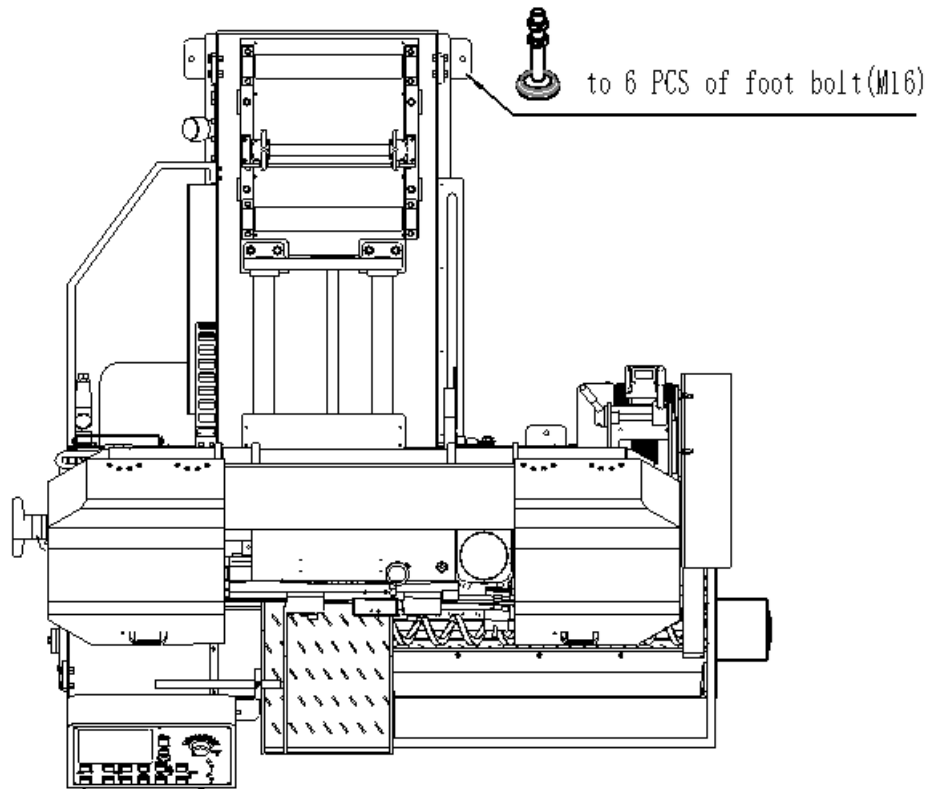

- When vertical movement of the spirit level, the permissible error must be less than 0.1/1000.
- When lateral movement of the spirit level, the permissible error must be less than 0.1/1000.
- It is very important for cutting precision to adjust the level of the machine.
- Please select and use the spirit level which has a precision of 0.02mm/m.

#### 3.5 Hydraulic Oil

Check the indicator of hydraulic oil as shown in figure.

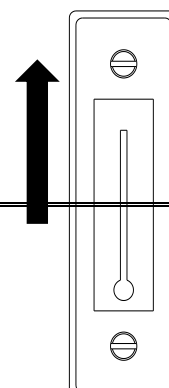

### 3、 Installation and Adjustment

---

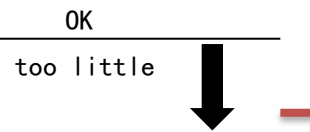

#### 3.6 Coolant Water

Has emptied the coolant water before leave factory, so please add  
The coolant water and saponification liquid before using the machine.



- Need to cleaning the machine the end of daily work and/or no use for a long time to protecting rusty the machine.



- It is possible to damage the water pump that the pump work without cooling water.
- In the winter, it is necessary to add warm water to thaw out frozen cooling water.

## 3、 Installation and Adjustment

---

### 3.7 Power

60Hz 230V or 60Hz 460V 3P



- Electrical operation must complete by professional electrician.
- Power off all of relay.
- Wire must be fitted in with standard voltage parameters.

### Trail running of machine

To rotate right and pull the power switch, the green indicator light means power on. The saw frame will lift when to press the saw frame up button, otherwise it indicate The wrong of power connection, please re-connecting power as follower.

- ① turn off the power switch
- ② power off all of relay
- ③ transpose the power phase
- ④ trail running of machine again





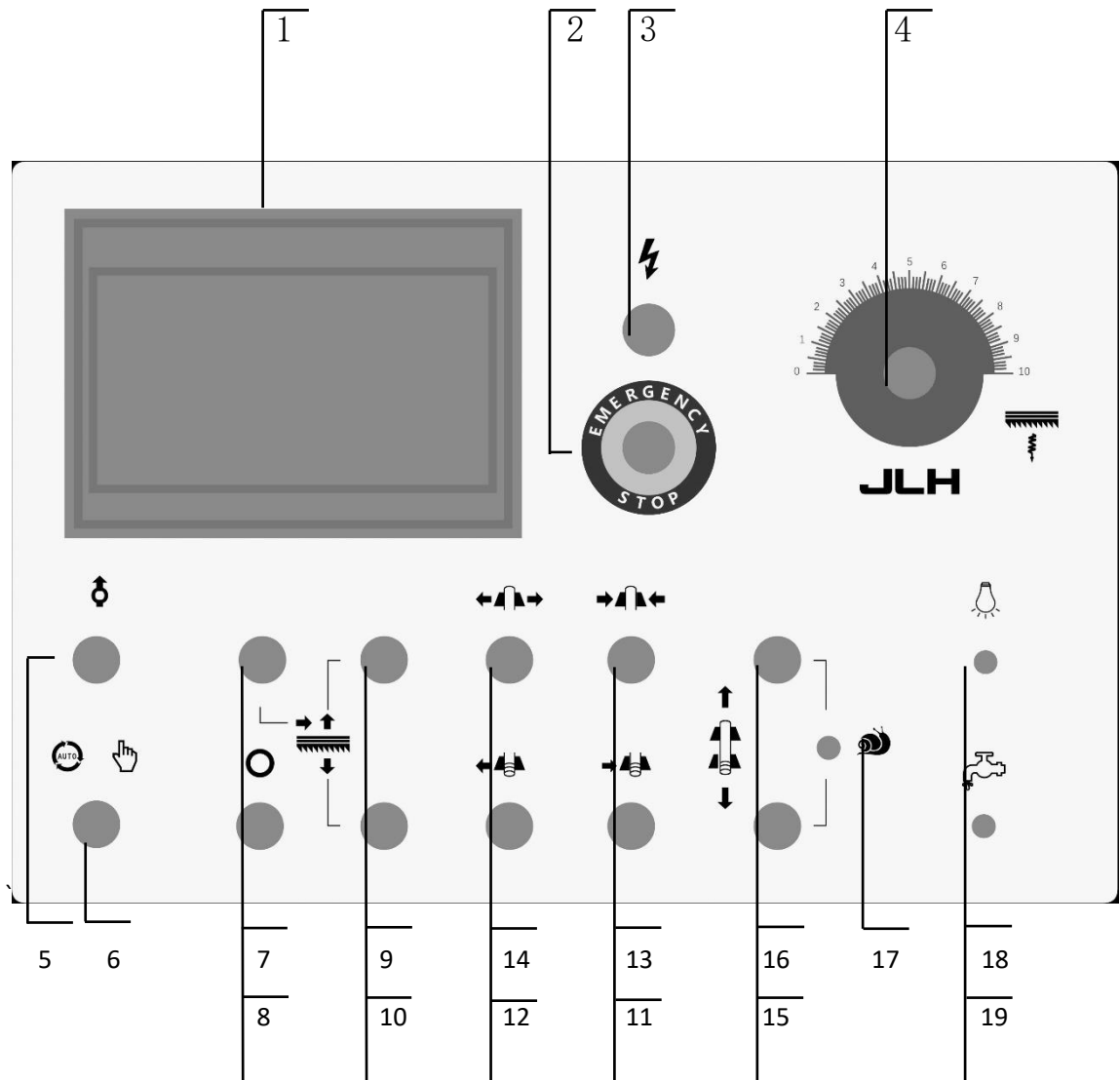







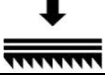

## 4、 Instruction Manual

### 4.1 Operation Panel



symbol	Description	Function
1	HMI	machine control\data setting\condition monitor, details refer to instruction
2	emergency button	press to emergency stop machine, loosen to reset
3	power indicator	light on indicate power on

## 4、 Instruction Manual

4	feeding adjust valve		Turn left or right to adjust the feeding speed, speed higher when value higher.
5	oil pump on-off button		Press this button to start pump when pump is off, press this button to stop pump when pump is on.
6	auto/manual transfer switch		Turn right to manual work mode, turn left to auto work mode.
7	Work start button		Press it saw wheel will work and work feeding when in "manual mode". press it machine will go circulation work if has be back to original when in "auto" mode.
8	Work stop button		Press it machine saw wheel will stop machine stop work feeding when in "manual mode", press it machine will auto pause when in "auto mode"
9	saw frame up button		Press it saw wheel will stop working and frame rise up when in "manual mode", press it machine will go back to original when in "auto mode"
10	saw frame down button		Press it saw frame will go down rapidly, magnetic valve on, loosen stop.
11	main vice clamp button		Press this button, the magnetic valve on, keep clamping.
12	main vice loosen button		Press it main vice will loosen, magnetic valve on, loosen stop.
13	material vice clamp button		Press it material vice will clamp, magnetic valve on, keep loosen.
14	material vice loosen button		Press it material vice will loosen, magnetic valve on, loosen stop.
15	feeding button		Press it roller will feeding material, magnetic valve on, loosen stop.
16	material return button		Press it roller will return material, magnetic valve on, loosen stop.
17	Feeding/return material speed switch		行。 Press it the light will on, buffer magnetic valve off, feeding/return material switch to slow running.
18	work light		Turn up to open, turn down to off.
19	water pump switch		Turn up to start water pump, turn down to switch off water pump



## 4、 Instruction Manual

### 4.2 Human-computer interface

#### 4.2.1 Preface

This instruction is only about the human-computer interface operation instruction. Reading this manual should be based on a certain understanding of the working principle, structure and related cutting process of the machine tool, so before this should carefully read the random "machine tool manual", combined with the relevant chapters to understand this description. This instruction has not done, please forgive more, if has not understood please consult with the manufacturer service personnel .

#### 4.2.2 开机画面 Boot screen



Boot into the manufacturer's promotional screen, the lower left corner is the button for English user. Click to enter the English interface. In the lower right corner is the button for Chinese users to enter the Chinese interface.

#### 4.2.3

#### 4.2.3 Manual working screen

## 4、 Instruction Manual

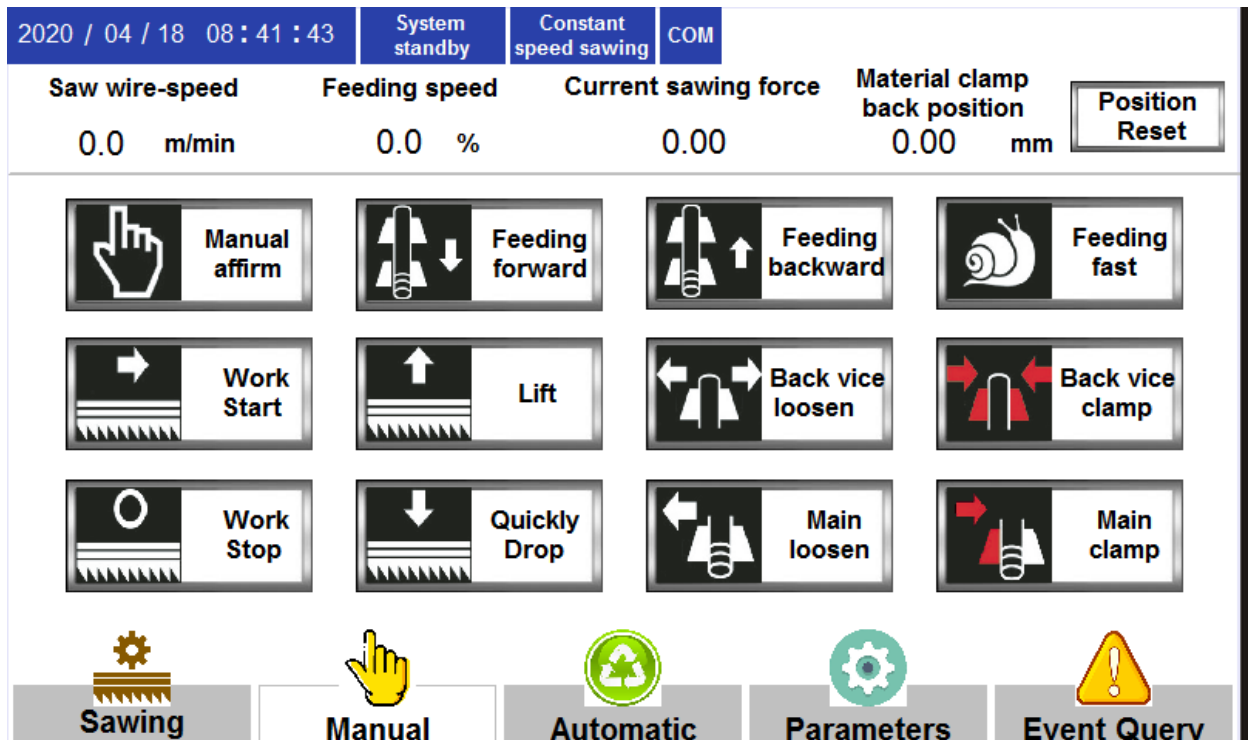

✘ To enable manual function, you must first switch the external button to manual shift, otherwise other buttons will be invalid

The upper part of the screen is the functional area Shared by all interfaces. The following description is applicable to the functional interface. It will not be repeated in the future.

**Clock display:** display time, date and other information. If there is any deviation from the local actual clock, the clock information can be calibrated in the human-machine setting interface.

**Current system status:** it shows whether the current system is in manual mode、auto mode、back or iginal mode, so that the operator can be clear at a glance.

**Cutting mode:** Display whether the current machining is constant speed cutting or variable speed cutting.

**Communication connection:** it is used to indicate whether the communication connection between the human-computer interface and the PLC is normal. The indicator light flashes when it is normal. Otherwise, the communication connection line with PLC should be checked.

## 4、 Instruction Manual

---

System status prompt bar: it indicates whether the current system is normal or abnormal.

### Saw

blade linear speed: the machine tool is equipped with a saw wheel rotation induction device. When the main machine is running, the system will detect the state of the high-speed signal device.

For the operator to determine whether the speed of the saw blade meets the requirements of the production cutting process.

Note: this function can only be used normally when the parameter "setting diameter of saw wheel" is set in the "advanced parameters" interface.

Cutting speed: Display the current working speed value.

Current sawing force: Display the current sawing force.

Return position of material tongs: The machine is equipped a magnetic grid linear displacement sensor, where the current position of the material table can be dynamically displayed in real time when the material table moves back and forth. This function enables the operator to observe the dimension positioning of the material rack at any time, and is conducive to the rapid troubleshooting of the feeding positioning fault of the machine.

This screen can complete the operation of machine all independent actions.

The work start is driven by motor, and other actions are all driven by hydraulic . Note that some actions has their interlocks, limit protection and other functions, listed as follows:

1. Only when the main clamp solenoid valve works, "work start" can be self-locking operation, otherwise for inching operation.
2. "work start", "main clamp clamping", "material clamp clamping", "rise" with self-locking function, other are inching.

## 4、 Instruction Manual

---

3. "main clamp clamping t" and "main clamp loosen", "material clamp clamping" and "material clamp loosen", "fast down" and "up", "feeding" and "return" are all interlocks.
4. When the work is started (cutting material), the "main clamp loosen" cannot be executed.
5. When the main clamp and the material clamp are both clamped, "feeding" and "returning" cannot be executed.
6. When the saw frame reaches the lowest position, the lower limit switch action, the saw frame will automatically turn into retractor.
7. When the frame reaches the upper limit switch position, the upper limit switch action, the saw frame stops

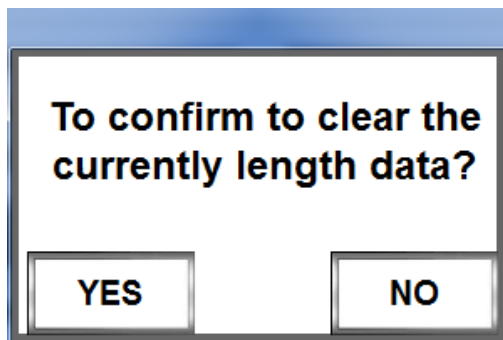

Reset position: under manual mode, the

system allows the machine operator to manually reset the position of the current rack. Press "reset position" to pop up the interface (as shown in the right picture), press "confirm" to reset, and press "close" to return.

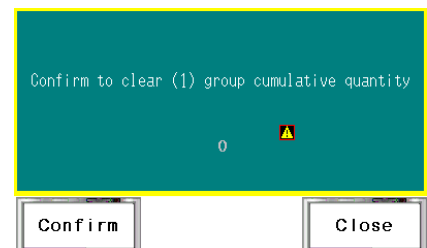

## 4、 Instruction Manual

This function can be used to perform simple material sawing positioning under manual working mode.

The lower area of the screen is the common function area of each interface, which is used for the switching of standby interface.

### 4.2.4 Auto mode screen

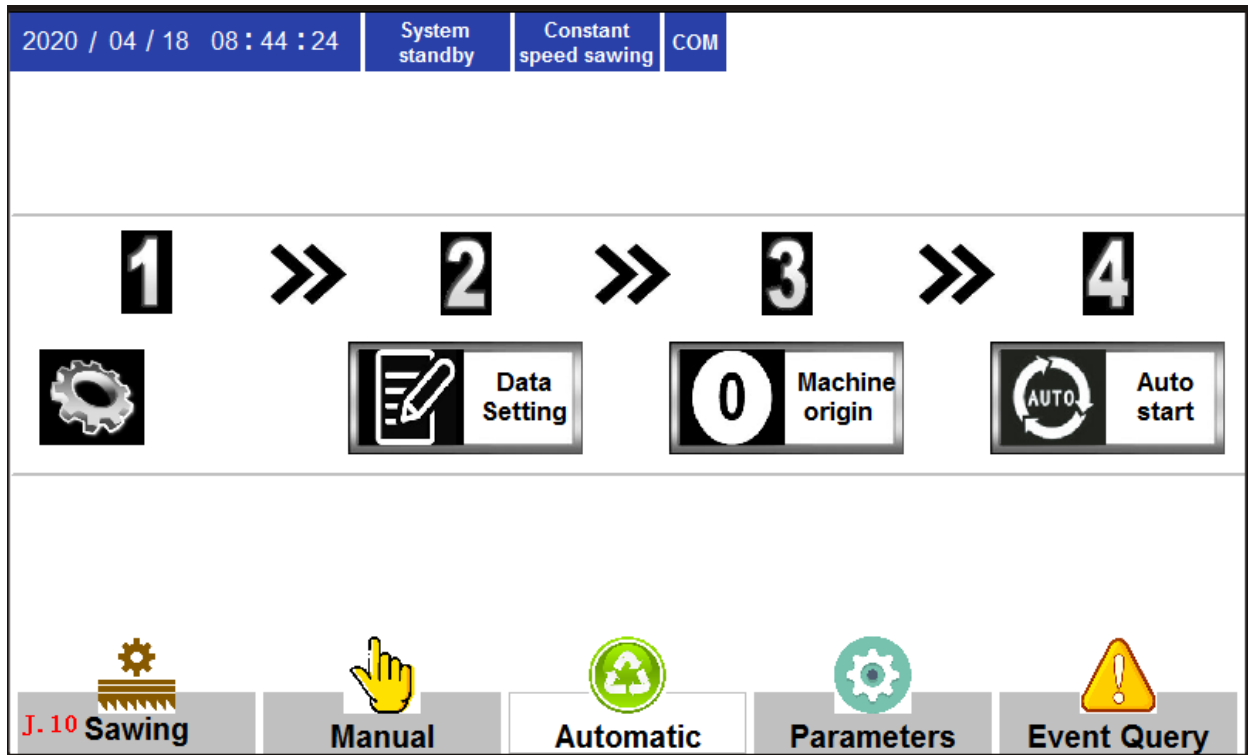

This screen mainly completes the setting, adjustment and monitoring of workpiece data in the automatic working mode, as well as the start and stop operation of the automatic process.

It is necessary to switch the external button to automatic shift when in automatic working mode.

Current linear speed of saw blade: Display the current saw blade linear speed.

Current sawing force: Display the current sawing force.

Cutting speed: Display the cutting speed.

Target sawing force: Display target sawing force.

## 4、 Instruction Manual

---

Return position of material tongs: Display return position of material tongs.

Current processing group: indicates which group of data the workpiece is being processed in the automatic cutting process.

Current machining size: shows the size of the workpiece being processed in the automatic cutting process.

Current group surplus: shows the number of pieces left to be processed in the data group being processed in the automatic cutting process.

**4.2.4.1**、 Sawing setting: Click this key to enter the sawing setting process.

(1) Assign values according to the prompts on the screen, and then click "next".

机

## 4、 Instruction Manual

Material model	Saw wire-speed<m/min>	Material model	Saw wire-speed<m/min>
low-carbon steel	50~75	carbon tool steel	40~50
medium-carbon steel	50~70	alloy structural steel	30~50
high-carbon steel	20~35	alloy spring steel	20~35
Bearing steel	35~45	Cold die alloy tool steel	20~35
Stainless steel	20~45	Hot die alloy tool steel	25~45

**Material line speed comparison table** 

Material linear speed comparison table:Click this key to enter the material line speed comparison table.This interface show that different material models correspond to different saw blade line speed.Convenient for users to set reasonable line speed.

## 4、 Instruction Manual

Material line speed  
comparison table

Please enter the appropriate line speed value  
of the saw band according to the material.

Then press "Next".

Current belt 0 gear Saw wire speed range 0.0 — 0.0

**Set the saw belt line speed**

0.0 m/min

**NEXT**

- (2) In this interface,select variable speed cutting or constant cutting,select constant speed cutting,and click 'OK' to exit the sawing setting process.select variable speed cutting and click "next" to set sawing parameters.



## 4、 Instruction Manual

---

Please select the corresponding shape according to the cross-sectional shape of the sawing material.

Then press "Next".

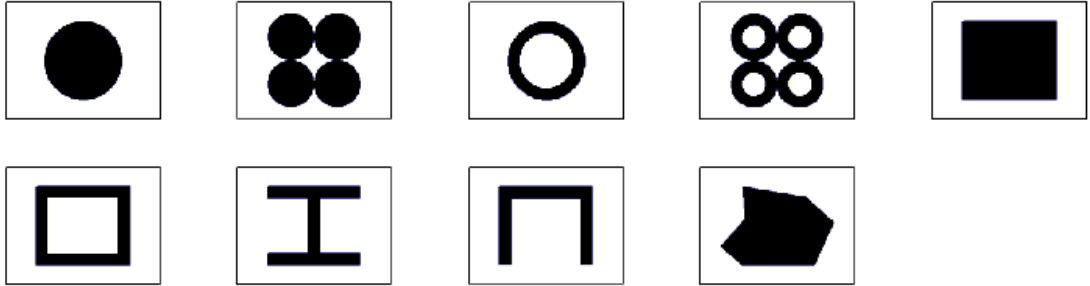

Return

Next

(3) Select the corresponding shape according to the sawing material, and then click "next".

## 4、 Instruction Manual

---

**Please set the target cutting force data and press "OK";**

**If you don't know the right data, press "Test Saw".**

**Set target sawing force**

**0.00**

**Test Saw**





**Return**

**OK**

(4) Set the target sawing force data and press "OK" to exit the sawing process .If you don't know the appropriate data,click the "trial saw" operator.

(5) Please carry out corresponding operation according to the prompts on the screen.when sawing to the maximum section of the material,extract the current sawing force as the target sawing force data,and press "OK" to exit the sawing setting process after cutting the material.

## 4、 Instruction Manual

No.	Option item	Machining size	Setted quantity	Total quantity	Saw Kerf
(1)	✕	0.0	0	0 	0.00
(2)	✕	0.0	0	0 	
(3)	✕	0.0	0	0 	Head
(4)	✕	0.0	0	0 	✕
(5)	✕	0.0	0	0 	

Maching Data Setting

**4.2.4.2** Data setting: click this button to switch to the processing data setting screen (as shown in the right picture).

This screen mainly completes the setting, adjustment and monitoring of each workpiece data in the process of processing.

The size (mm) and quantity of the workpiece to be machined must be set before automatic cutting function is enabled.

According to the user's daily processing requirements for various specifications of the workpiece, the system designs the processing data always in the order of "the first set" to "the fifth set"

The method of input value is: touch the data input area, and the human-machine interface will automatically pop up a numeric input keyboard (as shown in the figure on the right) to easily input the required data.

Pay attention to the input range prompted by the top of the keyboard, beyond which the man-machine will not accept

Gating: each set of data has a gating button, which is crucial.

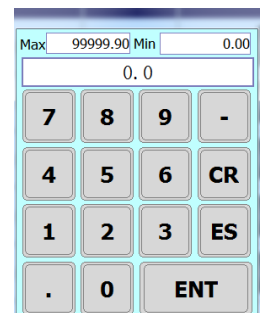

## 4、 Instruction Manual

---

Only when this group of data is selected will it be active in the automatic loop.

Touching the gating button shows that the "√" data set is valid, and touching the gating button again shows that the "×" data set is invalid.

"Processing size" : according to the requirements of the processing process input the required workpiece length (unit: 0.1 mm).

"Set number" : according to the production schedule, enter the number of workpiece required by the corresponding specification.

"Accumulated quantity" : dynamically displays the current accumulated quantity of the workpiece of the corresponding size, which is convenient for production statistics.

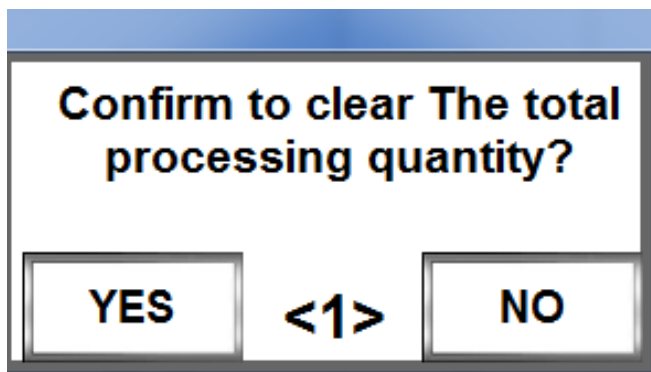

。 If it is necessary to reset the current accumulated processing quantity in this group, press the "reset" button, and the system will pop up a dialog box (as shown in the right figure). Press "confirm" to clear the data, and then press "close" button to return to the interface.

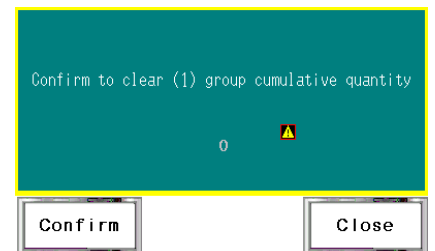

"Saw seam compensation" : this is used to correct the saw blade thickness or other mechanical small deviation caused by the overall size error.

Generally, the input data is about 1.00–2.00. If the workpiece size is small, the data will be increased; if the workpiece size is large, the data will be decreased.

## 4、 Instruction Manual

---

The specific value depends on the site.

"Head mode": This function is optional. When "x" is displayed, the function is off, when "√" is displayed, the function is on. When the function is turned on, when the automatic start-up is started, the cutting head of a knife is automatically sawed first and then the automatic normal action is carried out.

**4.2.4.3** Machine back to original button: the machine automatically moves each functional component to the initial preparation position, namely the origin of the machine, to prepare for automatic sawing.

The action flow of returning to the origin is as follows:

- (1) Stop the operation of the saw wheel and raise the saw frame to the upper limit switch.
- (2) front clamp clamping and rear clamp clamping.
- (3) front clamp clamping and the rear clamp loosen.
- (4) feed to the origin switch.

**4.2.4.4** Automatic start button: press this button to start the automatic cutting process, and the machine will automatically complete multiple cycles from feeding positioning to precise cutting according to the set parameters.

It should be noted that the following aspects of work should be done before "automatic start" :

0

Automatic stop button: press this button to suspend the machine after the current workpiece is sawed. If you want to cancel the pause, press "automatic start" again.

### 4.2.5 Fine tuning screen of sawing

## 4、 Instruction Manual

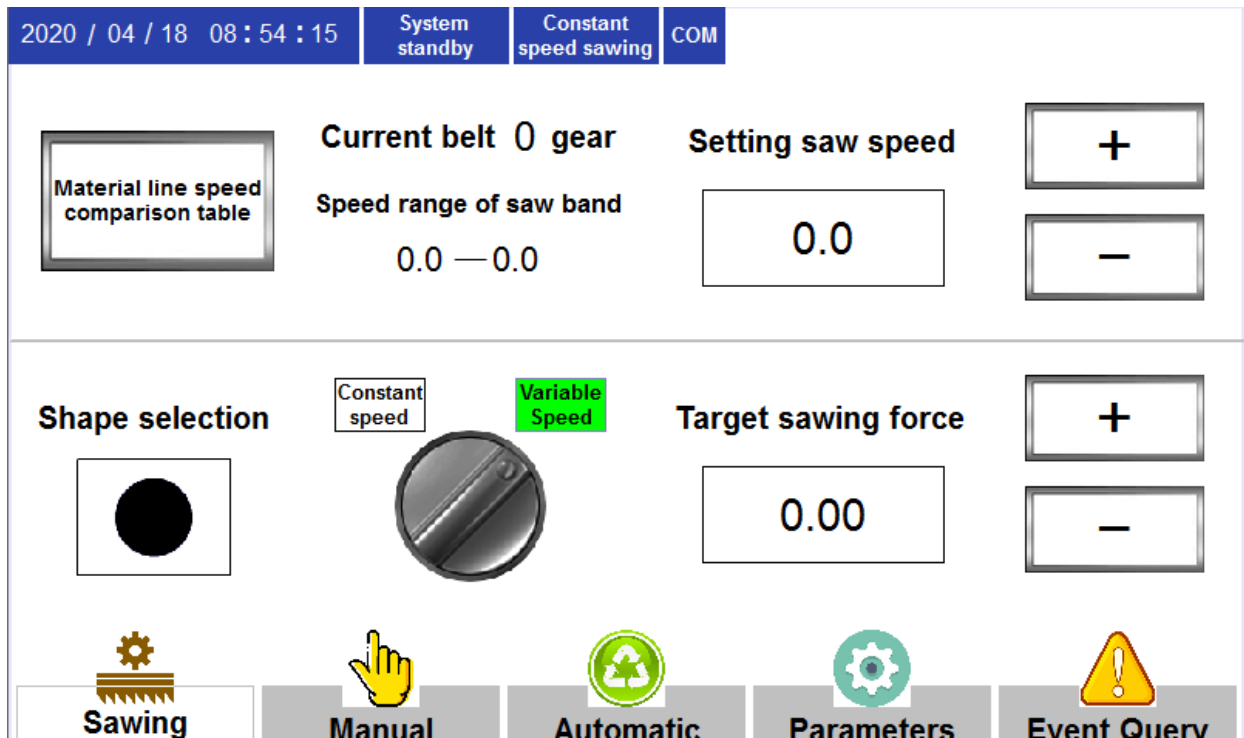





This screen is mainly used for setting the adjustment of sawing data.

Set the line speed of saw blade: Set the corresponding line speed of saw blade according to the material. According to the actual situation, fine-tuning the line speed of the saw blade is carried out through the buttons on the screen.

Target sawing force: Select the corresponding material shape to set the appropriate sawing force, and fine tune the sawing force through the buttons on the screen according to the actual situation.

### 4.2.6 Advanced function screen

## 4、 Instruction Manual

2020 / 04 / 18 08 : 58 : 16		System standby	Constant speed sawing	COM	
Main jaw time— —clamp	<input type="text" value="0.0"/>	loosen	<input type="text" value="0.0"/>	<Sec>	HMI
Back vice time— —clamp	<input type="text" value="0.0"/>	loosen	<input type="text" value="0.0"/>	<Sec>	Status
<b>Variable Speed Sawing</b>					Advanced
Initial opening	Maximum openness	Minimum opening			
<input type="text" value="0.0"/> %	<input type="text" value="0.0"/> %	<input type="text" value="0.0"/> %			
Material detect	<input checked="" type="checkbox"/>	Saw blade detect function	<input checked="" type="checkbox"/>		Pulley gear
 Sawing	 Manual	 Automatic	 Parameters	 Event Query	

☆、 All parameters of this screen must be set before automatic cutting.

The time value of the main clamp clamping and loosening (unit: seconds) determines the working time of the main clamp controlling the solenoid valve under the mechanical return origin and automatic working mode.

The time value of clamping and loosening of the material clamp (unit: seconds) determines the working time of the material clamp to control the solenoid valve in the mechanical return point and automatic working mode.

It should be noted that the set time for clamping the vise is larger than the set time for loosening the vise.

Initial feed speed: Enter the initial feed speed of variable speed cutting here.

Upper limit of working speed: Enter the upper limit of working speed for variable

## 4、 Instruction Manual

speed cutting here.

Step change low speed: Enter the step change low speed value of variable speed cutting here. This item is applicable to material with sharp section change.

No material detection function: this function is optional, the function is closed when "×" is displayed, and the function is opened when "√" is displayed. The system is equipped with a no-material detection device. When the material on the rack is processed, the system will judge the no-material according to the state of the sensor in the process of discharging the material. When the material in the current cutting is finished, the system will stop the subsequent automatic process.

Blade broken detection function: this function is optional. When "×" is displayed, the function is closed; when "√" is displayed, the function is on. It is generally recommended to turn on the function. The system is equipped with a broken blade detection device. The system will judge the movement of the blade according to the set time interval. In case of dull running, cassette or broken belt, the system will stop in time to avoid more damage

### 4.2.7 Man machine setting screen

This interface (as shown in the figure below) can change the basic settings of touch screen.

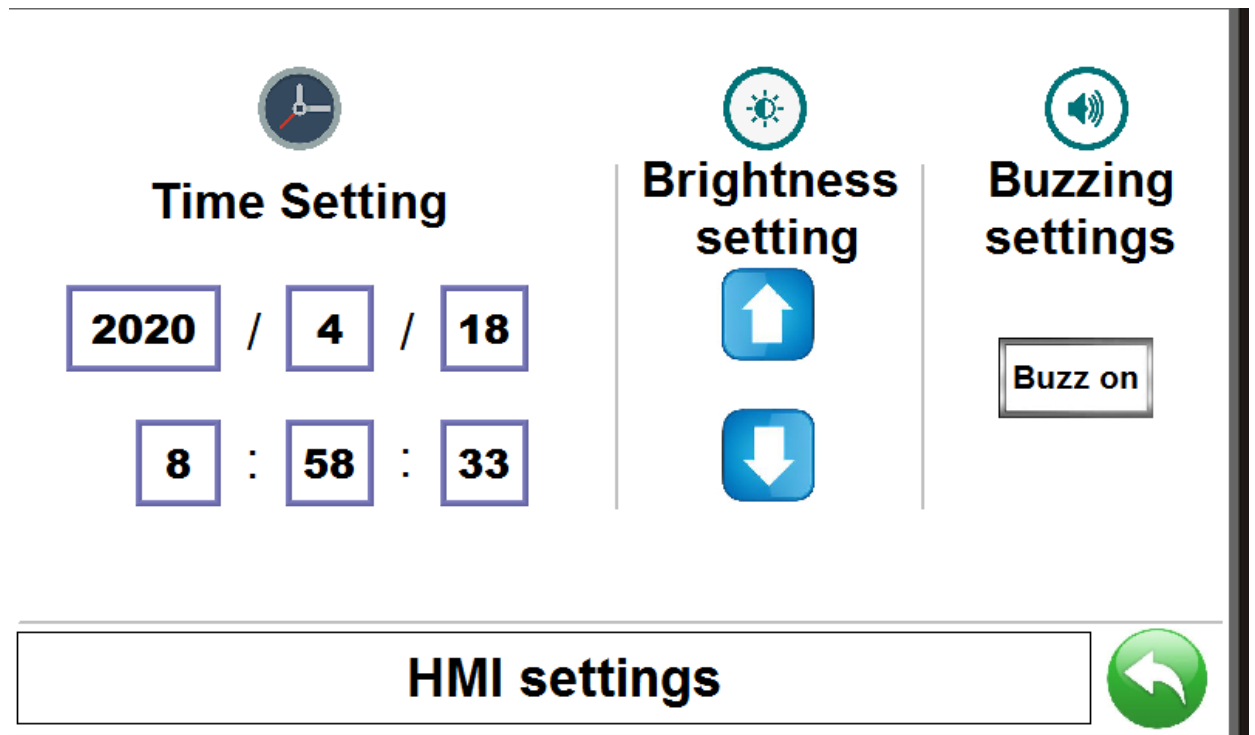



## 4、 Instruction Manual

Time setting: if there is a deviation from the actual local clock, enter the correct information here.

Brightness setting: adjust the brightness of the touch screen as needed

Buzzer Settings: choose whether to turn on buzzer sound effects as needed.

### 4.2.8 Status monitoring screen

<b>detection (Input)</b>	Hand vein A	Hand vein B	Up limit	Down limit	Origin limit	Saw blade	No material	<b>Start-up time</b> 0 : 0
<b>Button (Input)</b>	Work start	Oil pump on	water pump on	Main clamp	Main loosen	Back vice clamp	Back vice loosen	
	Work stop	Auto/Manual	Fast/Slow	Feeding forward	Feeding backward	Rise	Quickly Drop	<b>The number of cutting knives</b> 0 knife
<b>Load (Output)</b>	saw wheel	Water pump	Oil pump	Main clamp	Main loosen	Back vice clamp	Back vice loosen	
	Fast feed	Feed run	Rise	Feeding forward	Feeding backward	Buffer	Valve Pulse	

## System Status Monitoring



This screen completes the status indication of each switch signal. It is convenient for production operators to monitor the machine status in real time. At the same time, it is also helpful for production debugging and quick inspection when the fault occurs.

Detection signal (input) : indicating the working status of the limit switch and the detection switch of the machine, and lighting up when the switch is in action (green).

Button signal (input) : machine button input status indication, when switch in action light up (green).

## 4、 Instruction Manual

Load control (output) : motor and solenoid valve working status indication, when in action light up (green).

### 4.2.9 Advanced parameter screen:

Broken band detection time:	<input type="text" value="0.0"/>	<Sec>
Rise Delay Time:	<input type="text" value="0.0"/>	<Sec>
Many times setting	<input checked="" type="checkbox"/> second <input type="text" value="0.0"/>	third <input type="text" value="0.0"/> fourth <input type="text" value="0.0"/> <MM>
Sawing Wheel Holding Function	<input checked="" type="checkbox"/>	
Oil pump automatic stop	<input checked="" type="checkbox"/> <input type="text" value="0"/>	<Min>
<b>Advanced parameter settings</b>		<b>Model parameters</b>



☆ Enter this screen need to enter the correct permissions password

☆ Before automatic cutting must set the screen parameters.

Break detection time: Enter the appropriate break detection time here.

Rise delay time: when the input time is zero, it means that the model has no fast drop bar function.

When the input time is larger than zero, it means that this model has the function of fast lowering lever. The rise delay time is the set value.

Multiple feeding compensation: when the sawed material is too long and needs multiple feeding

## 4、 Instruction Manual

to locate the size, the compensation of one, two, three and four times feeding can be input to increase the accuracy of the size.

Saw wheel retention function: select this function, the machine will automatically operate the saw wheel after the first cut is completed, until the "number of processing" is zero or automatic suspension

Automatic stop function of oil pump: This function is optional. When "x" is displayed, the function is closed, when "√" is displayed, the function is opened. When the operator leaves the a long time, in order to save power and unnecessary loss of hydraulic system, the system will automatically time, when the set time value is reached, the hydraulic system will be closed to realize the total stop of the machine.

### 4.2.10 Model parameter interface :

Type

parameters: This interface mainly sets the machine model parameters.

Belt pulley gear	1gear	2gear	3gear	4gear	
Frequency conversion minimum line speed display	0.0	0.0	0.0	0.0	
Frequency conversion maximum line speed setting	<input style="width: 50px;" type="text" value="0.0"/>	<input style="width: 50px;" type="text" value="0.0"/>	<input style="width: 50px;" type="text" value="0.0"/>	<input style="width: 50px;" type="text" value="0.0"/>	<m/min>
Saw wheel diameter:	<input style="width: 50px;" type="text" value="0"/>	<mm>	Saw wheel rated current:	<input style="width: 50px;" type="text" value="0.00"/>	<A>
Oil cylinder feed stroke:	<input style="width: 50px;" type="text" value="0"/>	<mm>	Buffer stroke:	<input style="width: 50px;" type="text" value="0.0"/>	<mm>
Process selection in clamp	<input checked="" type="radio"/>			<input type="radio"/>	
				<input type="button" value="Default values"/>	
<b>Model parameter setting</b>					

Maximum line speed setting of frequency conversion: Here input the highest line speed of each gear frequency conversion.

## 4、 Instruction Manual

Diameter setting of saw wheel: in order to display the data of "saw blade speed" correctly on the screen of each function, the diameter parameter of saw wheel must be set correctly here before it can be used normally.

**Rated** current of saw wheel: Enter the rated current of saw wheel motor here. Obtain the current value of each gear.

Cylinder feeding stroke: for long size workpiece, the system will automatically feed the material several times to reach the set size. A single feeding stroke is set here, generally the effective stroke of the cylinder (unit: mm).

Positioning buffer stroke: The machine tool is equipped with buffer device for more accurate size positioning. Return positioning is divided into two sections--quick and slow, therefore, a stroke at the positioning end needs to make the buffer device act, and the action distance of the buffer device is set here.

Process selection in clamp: this function is optional. It is closed when "X" is displayed and opened when "√" is displayed. When the function is on, when the saw frame feed reaches the lower limit position, the main clamp loosens and then rises. When the function is off, the main clamp keeps clamping and rises when the saw frame feed reaches the lower limit position.

"Default value" : long press 1 second to restore all parameters to factory Settings.

**Saw wheel motor**

Note: The gear value set by the touch screen, Must match the actual gear position.

Reference line speed range:

1gear:	0.0 — 0.0
2gear:	0.0 — 0.0
3gear:	0.0 — 0.0
4gear:	0.0 — 0.0

Slow 1 gear 2 gear 3 gear 4 gear Fast

**Setting the belt gear**

0 <Gear>

**Belt gear settings**

Belt gear position: Input the current gear according to the actual pulley gear

## 4、 Instruction Manual

### 4.2.11 Alarm query interface

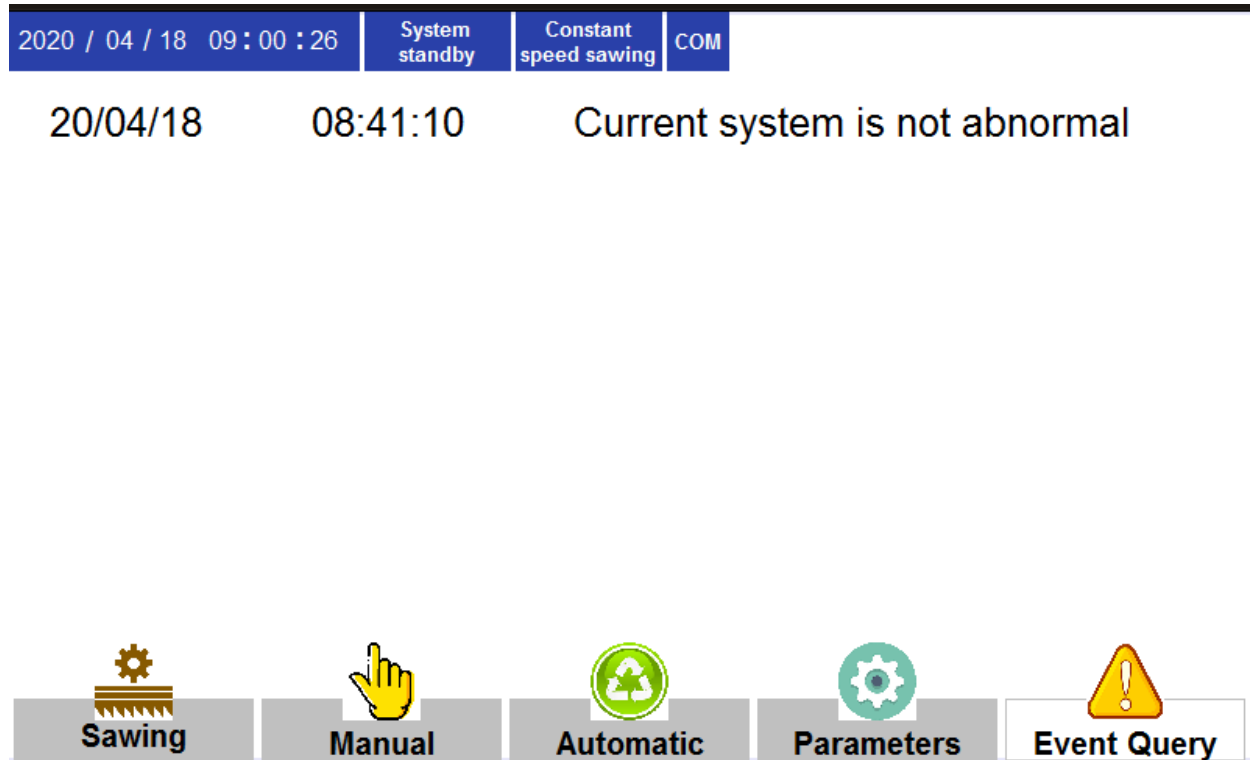

This interface displays the system history event status. The user can query the history alarm information in this screen.

### 4.3、 Touch screen fault and troubleshooting strategy

Number	Fault phenomenon	Elimination strategy
1	Touch the function buttons such as oil pump start and stop, the machine dose not respond(the indicator light of "communication connection" dose not flash)	<ul style="list-style-type: none"><li>◆ The communication cable on the back of the touch screen is loose.Plug it in again and tighten it by hand.</li><li>◆ The PWR or RUN indicator light o PLC in the electric box is not on,please refer to PLC manual for troubleshooting.</li><li>◆ Touch screen body</li></ul>

## 4、 Instruction Manual

		faulty,return to factory for maintenance
<b>2</b>	The boot screen is displayed normally and cannot be switched to other interface.	<ul style="list-style-type: none"> <li>◆ The touch panel is damaged and returned to the factory for maintenance.</li> <li>◆ Touch panel fault,return to factory for maintenance.</li> </ul>
<b>3</b>	Black screen after power on,no display.	<ul style="list-style-type: none"> <li>◆ The power plug on the back of the touch screen is loose,plug it in again and press it tight</li> <li>◆ The switch power indicator in the electric box is not on.Please refer to the switch power manual for troubleshooting</li> <li>◆ Touch screen body is faulty,return to factory for maintenance.</li> </ul>

 Please carefully read the instructions in the “precautions”chapter and effectively implement them.Please pay attention to the daily cleaning and maintenance of the touch screen,which can greatly reduce the probability of touch screen failure!

### 4.4 Steel Brush

The saw blade will go through the steel brush when running,and the steel brush will clean

## 4、 Instruction Manual

---

The scrap iron automatically.

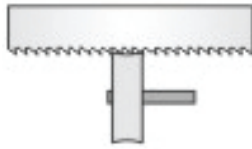

Right position

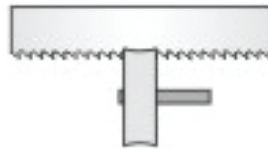

Inappropriate position

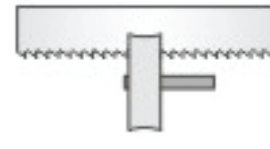

Wrong position



- Must power off machine and wear gloves when replace the steel brush.

### 4.5 hydraulic oil Indicator

Hydraulic oil is important media of Hydraulic system, so please observe oil capacity at any time.

The amount of oil must be kept at 1/3 above the red line. When the hydraulic oil is lower than this standard, the amount of oil must be replenished immediately. Otherwise, the hydraulic system of the sawing machine cannot work normally and even damages the hydraulic components.

### 4.6 Indicator of gearbox oil

Gearbox oil is important media of power system, so please observe oil capacity at any time.

The amount of lubricating oil in the reduction box must be kept above the submerged red point. When the amount of oil is lower than this standard, the amount of oil must be replenished immediately, otherwise, important parts of the gear box will be damaged.

### 4.7 Control valve of coolant water

The coolant water from the separate coolant water control valve can cool the band saw. The control valve can clean the steel brush according to our needs

## 4、 Instruction Manual

### 4.8 Replace Saw Band blade

#### 4.8.1 Remove Saw Band blade

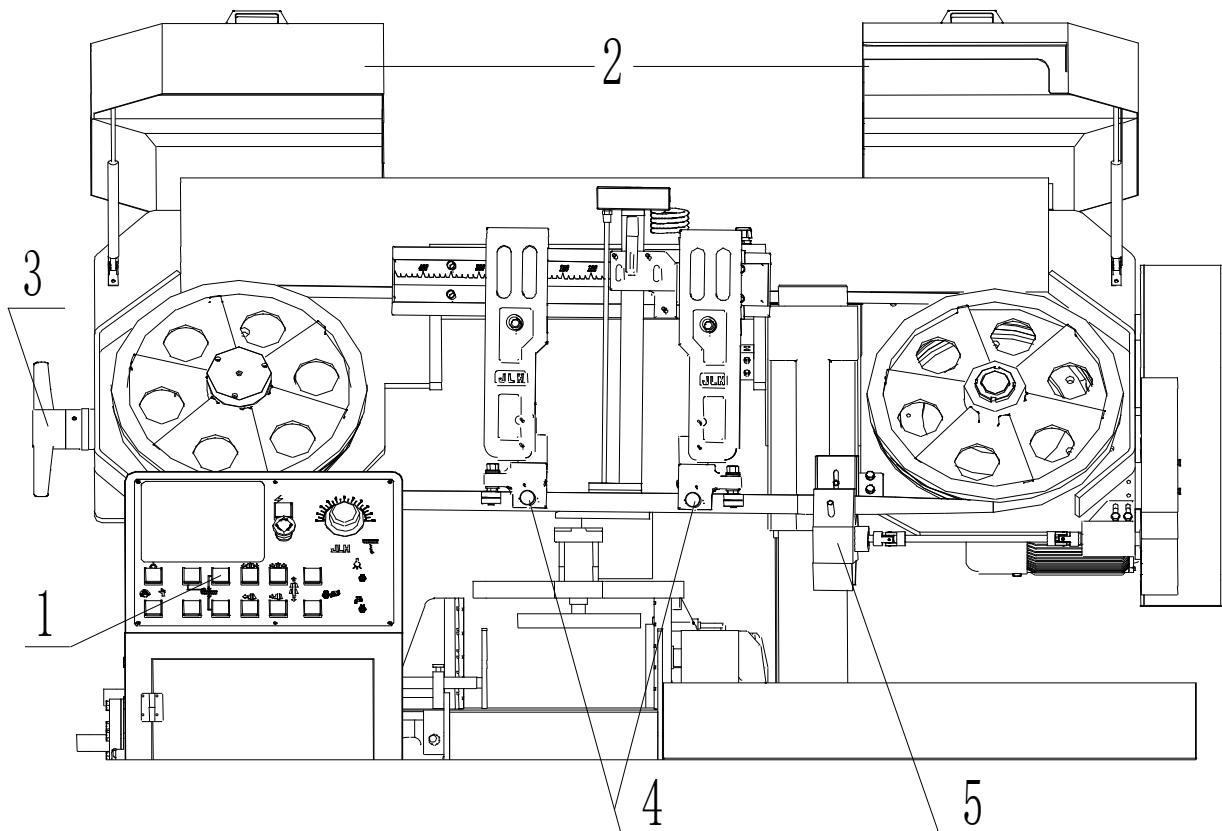

- 1. Press  to lift saw frame, at the highest position.
- 2. open the active wheel cover and passive wheel cover.
- 3. Loosen the saw blade tension seat bolt;
- 4. Loosen the nut on the regulating wheel seat on the movable guide arm and the fixing guide arm counterclockwise, and remove the saw belt;
- 5. Open the steel brush and take out the saw blade;
- 6. take out the saw band from the active and passive wheel



## 4、 Instruction Manual

---

### 4.8 Replace saw blade

#### 4.8.2 Put on saw blade

First to cleaning the accumulation of the scrap iron on the active wheel and passive wheel.

- 1.Put the saw band on the active wheel and passive wheel from behind of saw frame and
- 2.activities guide arm.
- 3.Set the saw band in the holder on guide arm.
- 4.Press the saw band in the groove of active wheel an passive wheel.
- 5.Put on the steel brush(refer to 4.2 chapter)
- 6.Close the cover of active wheel and passive wheel.



- 1.Must wear protection gloves before operation

### 4.9 Automatic mode operation

1.To choose Band Saw according to the material\size\shape of the workpiece.

2.To fix the Band Saw. (refer to 4.8 chapter)

3.To turn on the Power Switch.

4.Spin out "stop"button.

5.Set equipment operating data. (refer to 4.3 chapter)

6.Rotate to manual mode. 

7. 

To press and hold the Band Saw Up Button until the Band Saw come to higher position, in order to put the workpiece.

8.To put the workpiece on the worktable.

9. 

Press the " clamp" button, the clamping workpiece.

10. 

## 4、 Instruction Manual

---

Press the "Send" button, start to sending until the blade head, prominent location in front of 8~15mm.

11.  Press the " clamp" button, clamping the workpiece.

12.  To rotate the Flux Adjust Knob to 0 position.

13. To move the Guide Arm to the inside of the Activities Clamp between 30~100mm, and locking it.

14. To open the Belt Wheel Cover, and adjust running speed according to different Material. (refer to 6.2 chapter)

15.  Rotate to AUTO mode..

16.  To press down the Band Saw Switch, and running, start the automatic cutting;





17. To slowly rotate the Flux Adjust Knob to suitable position, 0.5 position is suitable when the new Band Saw ia be used.

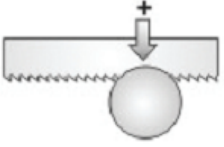

- 1. The new Band Saw must be sharpened.
- 2. To remove the workpiece and put down the Band Saw Frame to the lowest position.
- 3. Adjust the Flux Adjust Knob according to the material/size/sharp of workpiece and speed of the Band Saw.

To judge whether the speed of dropping and running of the Band Saw appropriate according to the shape of scrap iron?

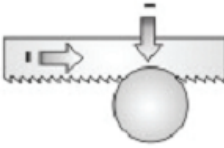
## 4、 Instruction Manual

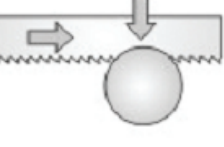
 <p>Powered Scrap Iron</p>	<p>Reason: the dropping speed of Band Saw is slower.</p> <p>Solution: Clockwise rotation of the Flow spill valve to fast the speed of Band Saw dropping.</p>	
 <p>Charred and blued Scrap Iron</p>	<p>Reason: the speed of the dropping and/or running of Band Saw is faster.</p> <p>Solution: Counterclockwise rotation of the Flow spill valve to slow the dropping speed of Band Saw (refer to NO.18 of 4.9 chapter), and slow the running speed of Band Saw(refer to NO.15 of 4.9chapter)</p>	
 <p>Circle Scrap Iron</p>	<p>The speed of the dropping and running of Band Saw is right.</p>	

Must clean the scrap iron on the machine after work be over daily.  
Stop the Band Saw, and open the cooling water valve, than the machine with cooling water jet.  
After cleaning job, put down the Band Saw Frame to lowest position, and then turn off the power.

### 5.1 maintain

Check the machine according to followed items before operation.

## 4、 Instruction Manual

---

1. To check the position of the Steel Brush(refer to 4.4 chapter).
2. To check the gearbox oil and hydraulic oil(refer to 4.5 and 4.6 chapter).
3. To check the Altimeter of cooling water,if it andicate the cooling water is not enough, you  
Asked to add cooling water.
4. To check and confirm the relative position between the Band saw,Active Wheel,Passive Wheel and Block-Oriented is right.
5. To check the Band saw Tension Wrench,and confirm the band saw has been tensioned.
6. To check the Tension of belt between the gearbox and motor.

## 4、 Instruction Manual

### 5.2 Lubrication

燕尾梁：每周涂上适量的润滑脂

Grease the Slideway of Guide Arm weekly with Molybdenum Disulfide  
Lithium-based Grease

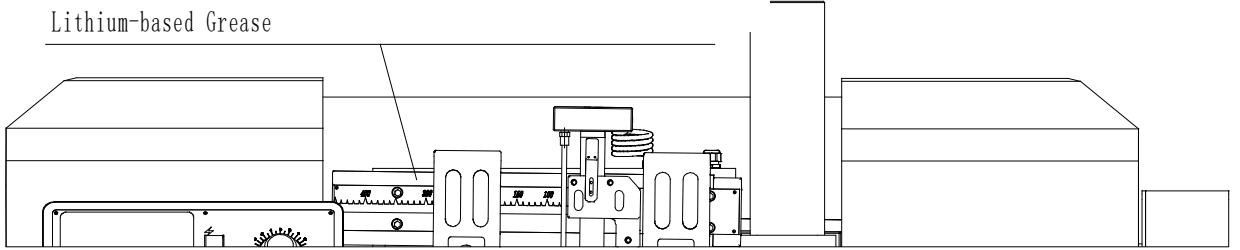

减速箱齿轮油(L-CK220) 在新设备使用的第一个月时需更换，以  
后每6个月更换1次。

To replace Gearbox Oil at the first month, hereafter  
replace Gearbox Oil one times every six months

每月至少两次加注润滑脂

To inject Molybdenum Disulfide  
Lithium-based Grease twice every month

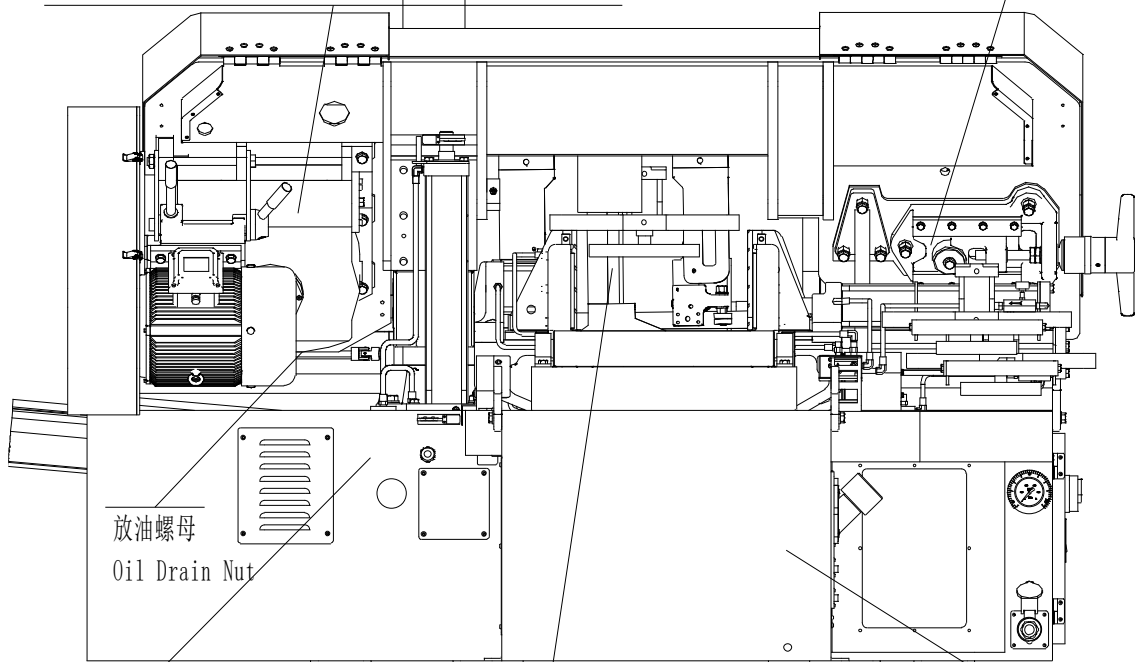

每天根据需要加注冷却水，  
冷却水必须清洁。

Add cooling water as  
needs, And it must be clean

每周涂上适量的润滑脂

To inject appropriate amount of  
Molybdenum Disulfide Lithium-based  
Grease every weekly.

液压油5年至少更换1次（矿物油型），每次55  
升





To replace Hydraulic Oil every five  
years at least. 55L every time.

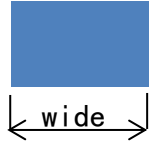
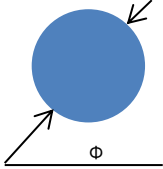

以上所有操作都必须关闭电源；The operation above must off Power

## 6、 Saw Band

### 6.1 Selecting the tooth of Saw Band

					
wide (mm/in)		Φ (mm/in)		Wall thickness (mm/in)	
1~5/ 3/64~13/64	14/18T	1~5/ 3/64~13/64	14/18T	1~3/ 3/64~1/8	10/14T
6~7/ 15/64~9/32	10/14T	6~10/ 15/64~25/64 4	10/14T	4/ 5/32	8/12T
8~13/ 5/16~33/64	8/12T	11~16/ 7/16~5/8	8/12T	5~6/ 13/64~15/64	6/10T
14~16/ 35/64~5/16	6/10T	17~21/ 43/64~13/16 6	6/10T	7~9/ 9/32~11/32	5/8T
17~25/ 43/64~1	5/8T	22~30/ 55/64~1- 3/16	5/8T	10~18/ 25/64~45/64	4/6T
26~53/ 1- 1/64~2- 5/64	4/6T	31~69/ 1- 7/32~223/32 2	4/6T	19~33/ 3/4~1-19/64	3/4T
54~114/ 2-1/8~4- 31/64	3/4T	70~144/ 2-3/4~5- 21/32	3/4T	>34 1- 11/32	2/3T
115~205/ 4-33/64~8- 1/16	2/3T	145~230/ 5-45/64~9- 1/16	2/3T	----	----
206~381/ 8-7/64~15	1. 4/2. 5T	231~ 381/9- 3/32~15	1. 4/2. 5T	----	----
>382/15	1/1. 5T	>382/15	1/1. 5T	----	----

## 6、 Saw Band

### 6.2 Suggestion of Saw Band speed

Material Model	GB	JIS	AISI	DIN	Saw Band speed Ft/min	Cutting rate Sq. in/min
Mild steel	08	S10C	1010	C10	164~246	10.8~12.4
	15	S15C	1015	C15	164~246	10.8~12.4
In carbon steel	45	S45C	1045	C45	164~230	9.3~10.3
	55	S55C	1055	CK55	164~230	7.7~9.3
Carbon tool steel	T10	Sk4	W1	C75W	131~164	3.8~7.0
	T12	Sk2	W1	C125W	131~164	5.4~7.0
	T8Mn	Sk2	W1	C125W	131~164	5.4~7.0
Alloy structural steel	40CrNi	SNC236	3140	40NiCr6	98~131	4.6~6.2
	40CrMoA	SCM440	4140	42CrMo8	131~164	5.4~7.0
	40CrNiMoA	SNCM439	4340	34CrNiMo8	115~147	4.6~6.02
High-speed steel	W18Cr4V	SKH2	T1	S18-0-1	82~115	3.1~4.6
	W18Cr4VCo5	SKH3	T4	S18-1-2-5	65~98	2.3~3.9
Alloy cold-die tool steel	Cr12MoV	SHD11	D2	X155CrVMo12	82~115	3.1~3.9
	CrWMn	SKS2	D7	105WCr6	65~98	2.3~3.1
	9SiCr	SKS3	D1	105WCr6	82~115	3.1~3.9
Alloy hot-die tool steel	3Cr2W8V	SKD5	H21	X30CrV93	115~147	4.6~5.4
	4Cr5MoV1Si	SKD61	H13	X40CrMoV51	98~131	3.9~4.6
	5CrNiMo	SKT4	L6	X55NiCrMoV6	82~98	3.1~3.9
Alloy spring steel	50CrVA	SUP10	6150	50CrV4	65~115	3.9~5.4
	50CrMnVA	SUP10	6150	50CrV4	65~115	3.9~5.4
Bearing steel	Gcr15	SuJ2	52100	100Cr6	115~147	4.6~6.2
Stainless steel	0cr18Ni9	SuS304	304	X5CrNi1810	115~147	3.1~4.6
	0cr17Ni12Mo2	Su316	316	X5CrNiMo171	65~82	2.3~3.1
	1Cr17	Su430	430	X6Cr17	98~131	3.9~5.4

## 6、 Saw Band

---

### 6.3 Grind in period of saw band



- 1. New saw band must go through Grind in period, and the Grind in period is one of the effective way to protecting the early damage of saw band.
- 2. The Sawing Speed in the Grind In Period is 1/3-2/3 of normal.
- 3. The Cutting Rate in the Gring In Period 1/4-1/3 of normal.
- 4. Reasonable Grind In Period must be to finishing 5-10 pcs work piece for example  $\phi$  4in(100mm )material.

### 6.4 The main reason of impact on using life

- 1. Tension is too large、Saw Band sudden change in the entrance of Guide Arm(Fixed guideArm)will likely lead to broken of Saw Band.
- 2. If the selection of sawing speed and(or)cutting rate is inappropriate will lead to Sawtooth broken.
- 3. The machine vibration will likely lead to sawtooth broken too.
- 4. The workpiece containing impurities will likely lead to sawtooth broken too.

### 6.5 Efficiency of Sawing

Loading Test according to the standard of JB/T4328.4-2002:

Material: steel45 (GB standard).

Diameter:  $\phi$  150mm.

Speed of Sawing:  $\leq$ 230ft/min.

Efficiency of Sawing: 12.4sqin/min

Efficiency of Sawing ( $\text{cm}^2/\text{min}$ ) =Area of workpiece (sqin) /Broken Time (min) .

95 $\text{cm}^2/\text{min}$  is available for thia model according to testing.



## 6、 Saw Band

### 6.6 Troubleshoot of saw band (一)

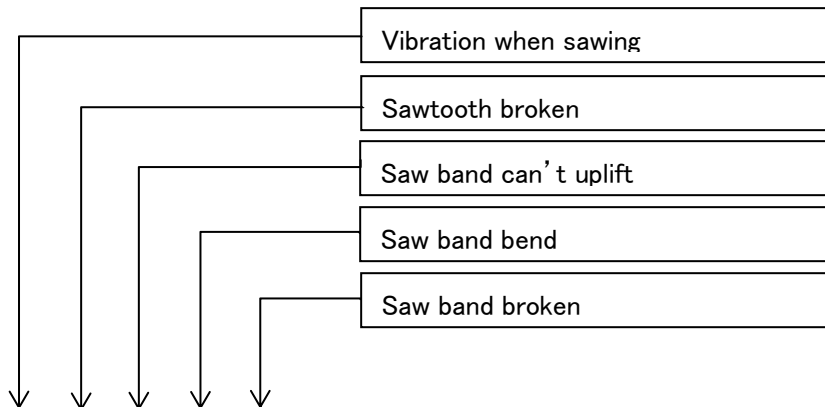

Trouble					Reason	Solution
△	△				Sawtooth selected is inappropriate	Select appropriate sawtooth
△	△				Inappropriate strickle of sawtooth	Strickle sawtooth again
△	△				Sawing speed is too fast	Slowdown the sawing speed
△					Sawing speed is too slow	Speed up the sawing speed
△	△		△	△	Band Saw Frame dropping pressure is too large	Slowdown the dropping pressure
△					Band Saw Frame dropping pressure is too small	Increase the dropping pressure
△					Saw Band tension is too large	Reduce the tension
	△		△	△	Saw Band tension is too small	Increase the tension
	△			△	Steel Brush Position is incorrect	Reinstall or replace the Steel Brush
△					Inappropriate holding of saw band in the holder on guide arm	Check and/or Adjust
△				△	Workpiece clamping is not enough	Check and/or Adjust
△	△			△	Surface hardness of workpiece is too high	Softening the surface hardness of workpiece
△	△		△		Cutting Rate is too large	Reduce the Cutting Rate

## 6、 Saw Band

### 6.6 Troubleshoot of saw band (二)

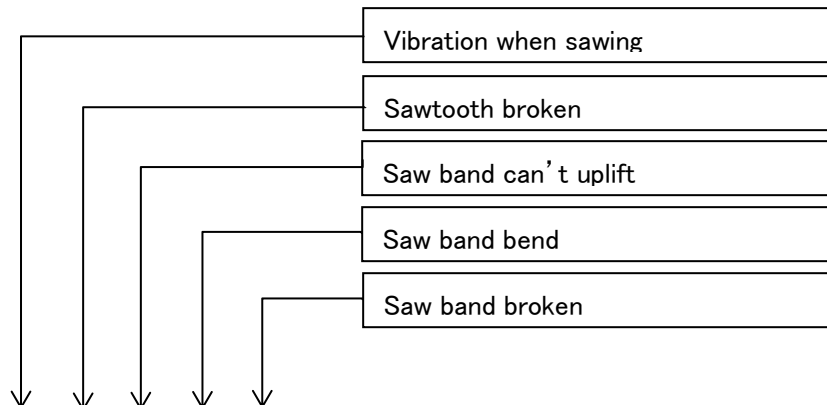

Trouble					Reason	Solution
△	△				The Cutting Fluid is too much or too little	Add , reduce or replace the Cutting Fluid
△		△	△	△	Machanical vibration	Replace the Tungsten Steel Guide Block
△	△				There are air in the Cylinder	Vent the air
△	△		△	△	The Tungsten Steel Guide Block is weared down	Replace the Tungsten Steel Guide Block
△					The Scrap Iron is blue or purple	Reduce the Cutting Rate
				△	The Scrap Iron accumulate around The Tungsten Steel Guide Block	Clean the Scrap Iron
△					Installation of Saw Band is inappropriate	Readjust
△					The Tungsten Steel Guide Block is too tight or too loose	Readjust
△	△				The Sawtooth is damaged	Replace the Saw Band
△					There are hard point in the workpiece	Move the workpiece

## 7、 Main Unit

### 7.1 Hydraulic System

#### 7.1.1 Pump stations

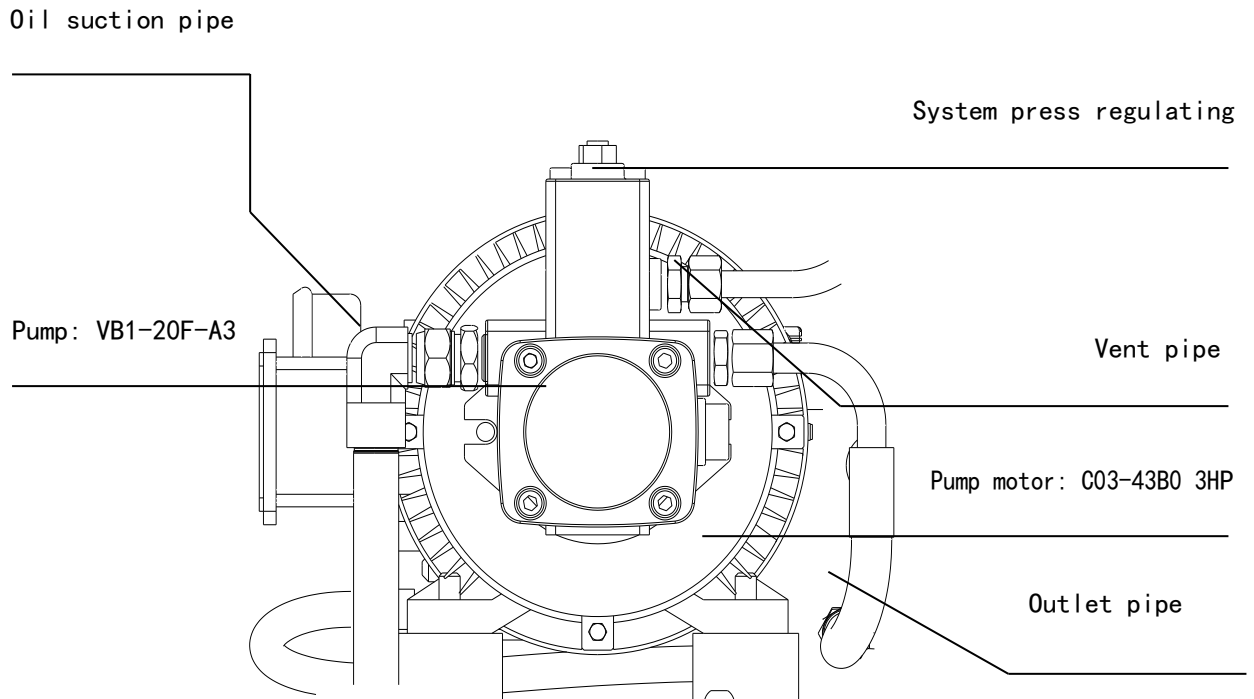

## 7、 Main Unit

### 7.1.2 Hydraulic System

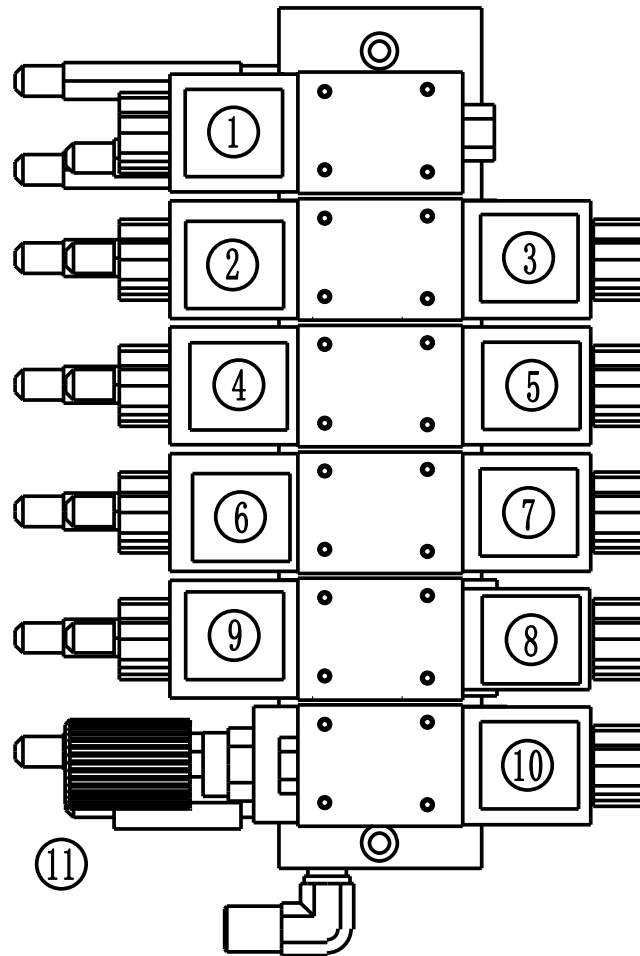

1. Work feeding: ② the coil is energized.
2. Fast forward: ②①the coil is energized.
3. Rise: ③① the coil is energized.
4. Main clamp clamping: ④the coil is energized
5. the main clamp loosen: ⑤ the coil is energized.
6. Material clamp clamping: ⑥the coil is energized.
7. Material clamp loosen:⑦ coil is energized.
8. Feeding: ⑧coil is energized.
9. Return material:⑨ coil is energized..
10. Feeding buffer: ⑧⑩ coil is energized.
- 11 return buffer: ⑨⑩ coil is energized.
12. Buffer adjustment for feed and return: clockwise, flow rate decreases.  
Counterclockwise, the flow is bigger.

# 7、 Main Unit

## 7.1.3 Hydraulic Schematic

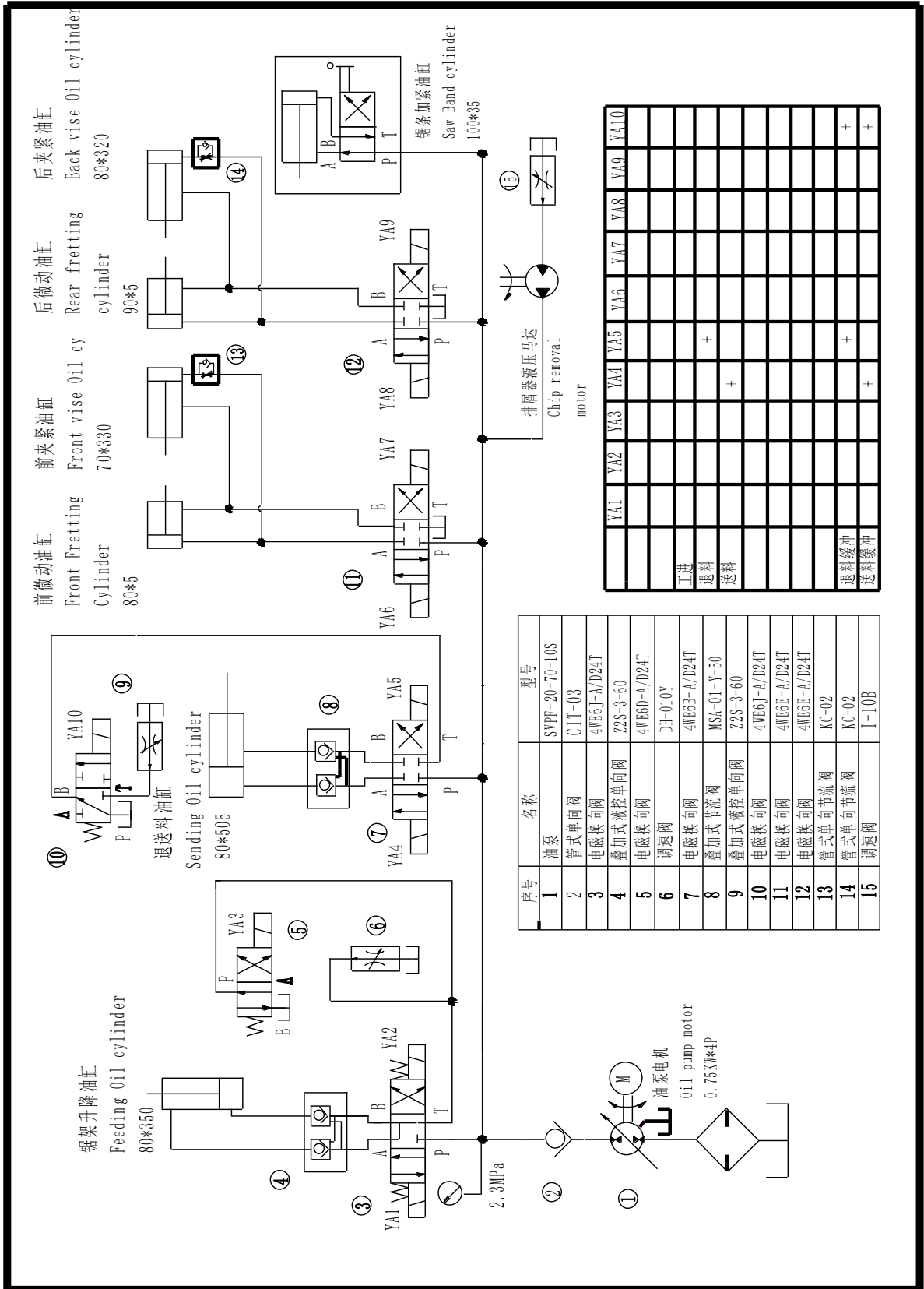

# 7、 Main Unit

## 7.3 Electrical system

### 7.3.1 Circuit Schematic Diagram

#### Main Circuit

C33

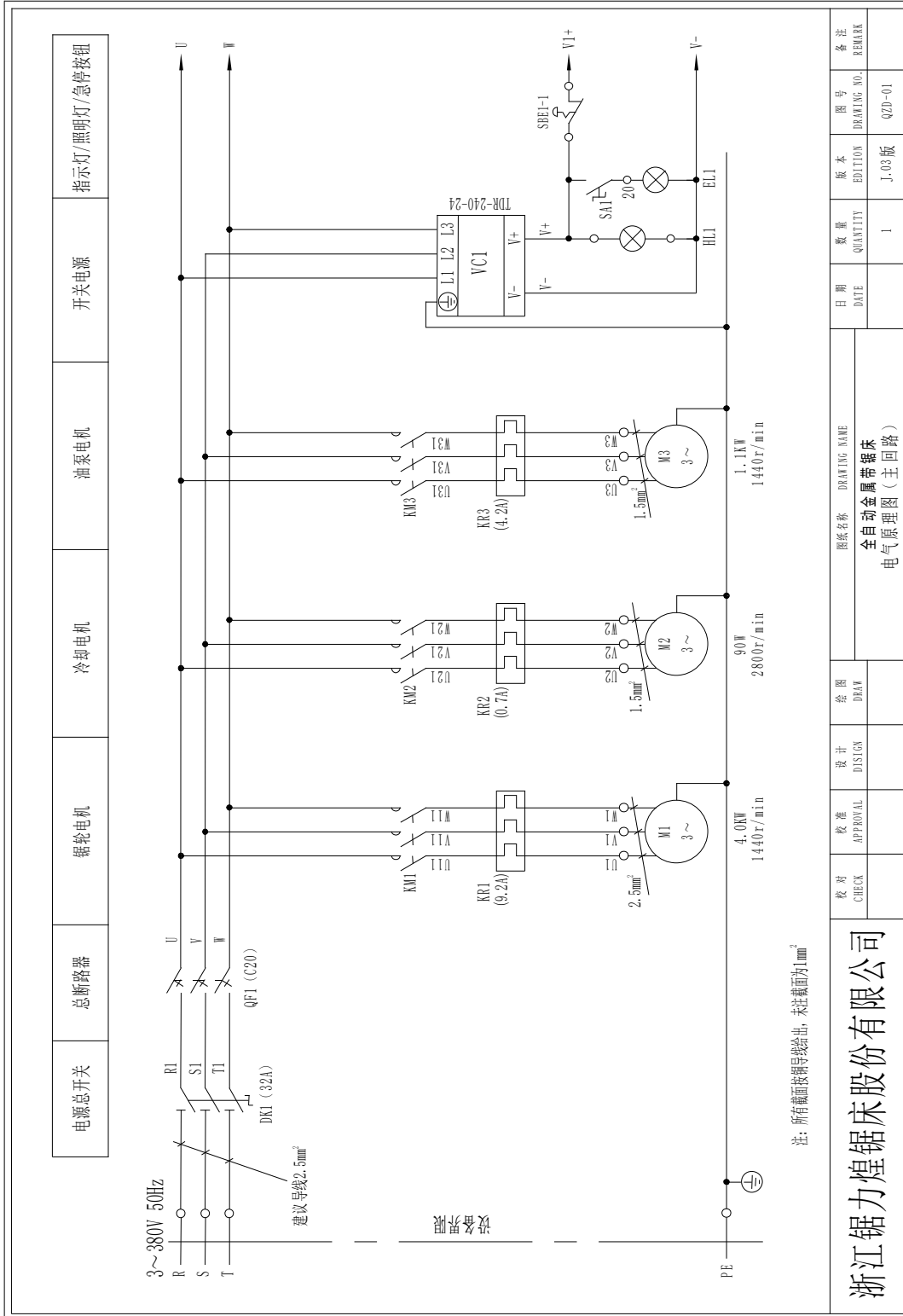

注：所有截面按导线给出，未注截面为1mm<sup>2</sup>

浙江锯力煌锯床股份有限公司

图样名称 DRAWING NAME  
全自动金属带锯床  
电气原理图（主回路）

校核	设计	绘图	审核名称	日期	数量	版本	图号	备注
CHECK	DESIGN	DRAW	图样名称	DATE	QUANTITY	EDITION	DRAWING NO.	REMARK
			全自动金属带锯床 电气原理图（主回路）		1	J.03版	QZD-01	

# 7、 Main Unit

## Control Circuit

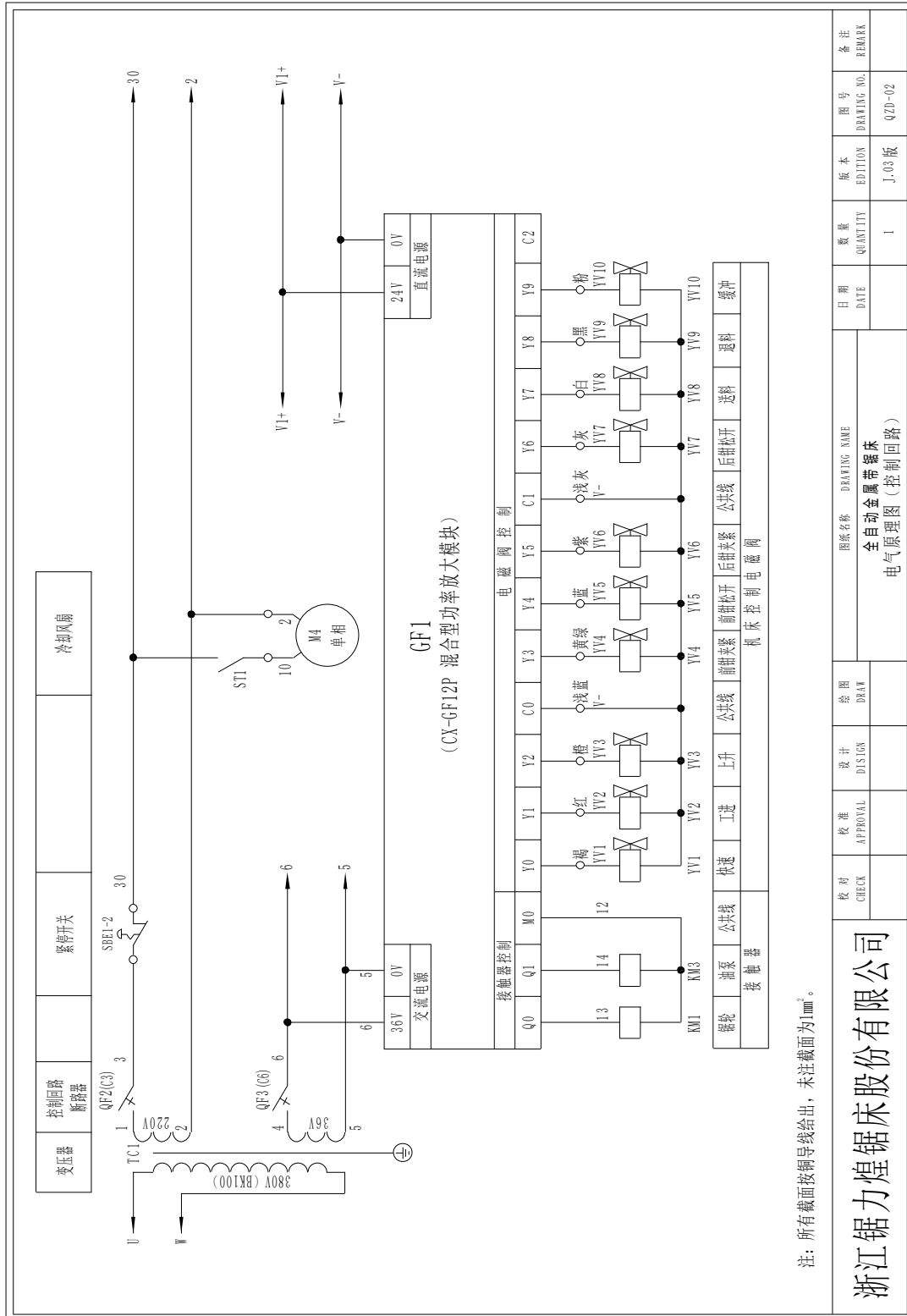

**浙江锯力煌锯床股份有限公司**

图样名称 DRAWING NAME  
**全自动金属带锯床**  
电气原理图（控制回路）

校核	设计	绘图	日期	数量	版本	图号	备注
CHECK	DISIGN	DRAW	DATE	QUANTITY	EDITION	DRAWING NO.	REMARK
				1	J.03版	QZD-02	

# 7、 Main Unit

## Control Circuit

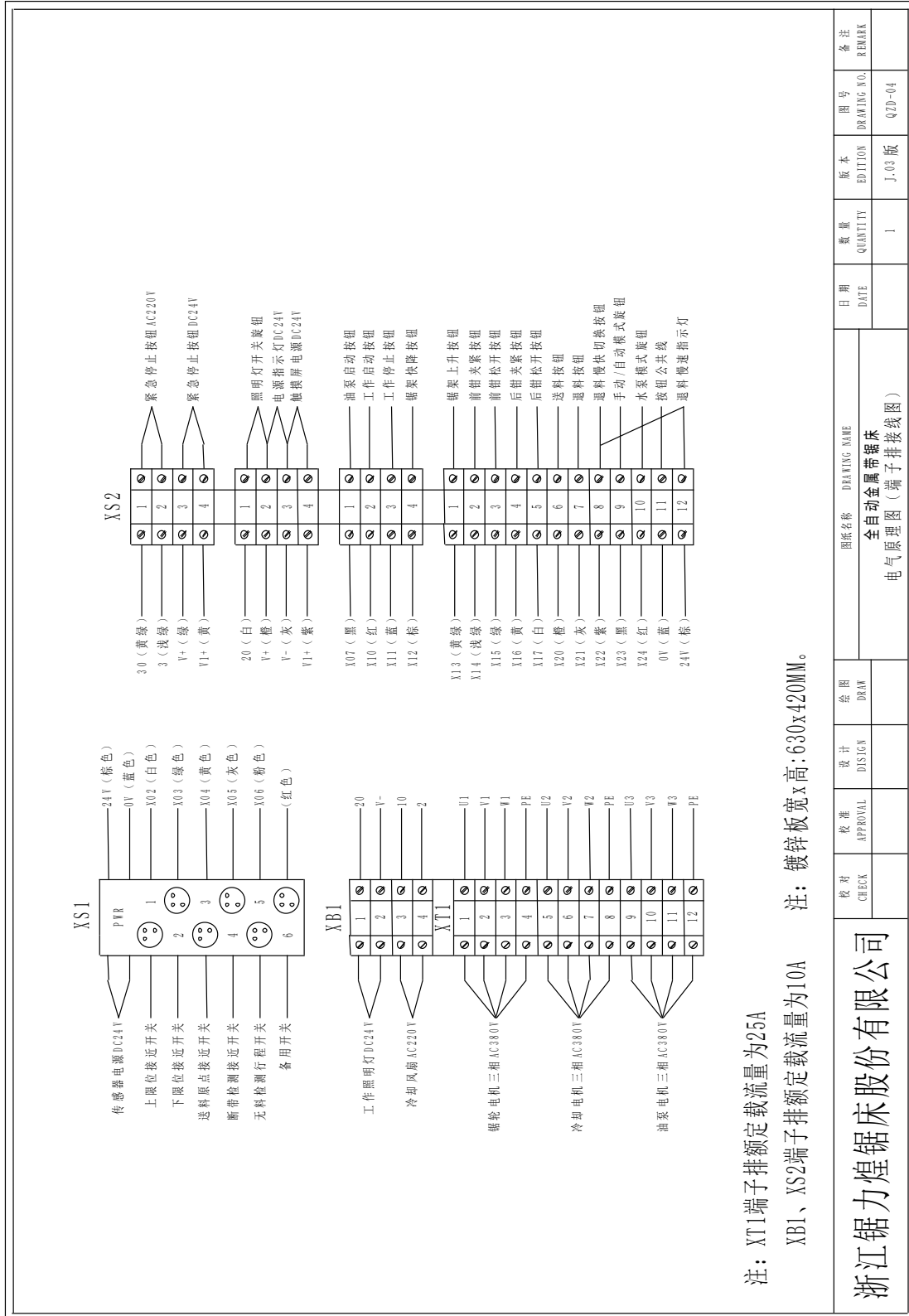

注：XT1端子排额定载流量为25A

注：镀锌板宽X高：630x420MM。

注：镀锌板宽X高：630x420MM。

浙江锯力煌锯床股份有限公司

校对	设计	绘图	图名	数量	版本	图号	备注
CHECK	DESIGN	DRAW	全自动金属带锯床 电气原理图（端子排接线图）	1	1.03 版	QZD-04	REMARK
批准	校核	审核	数量	日期	EDITION	DRAWING NO.	
APPROVAL	CHECK	APPROVAL	1	DATE	1.03 版	QZD-04	



# 7、 Main Unit

## 7.3.2 Circuit Schematic Diagram

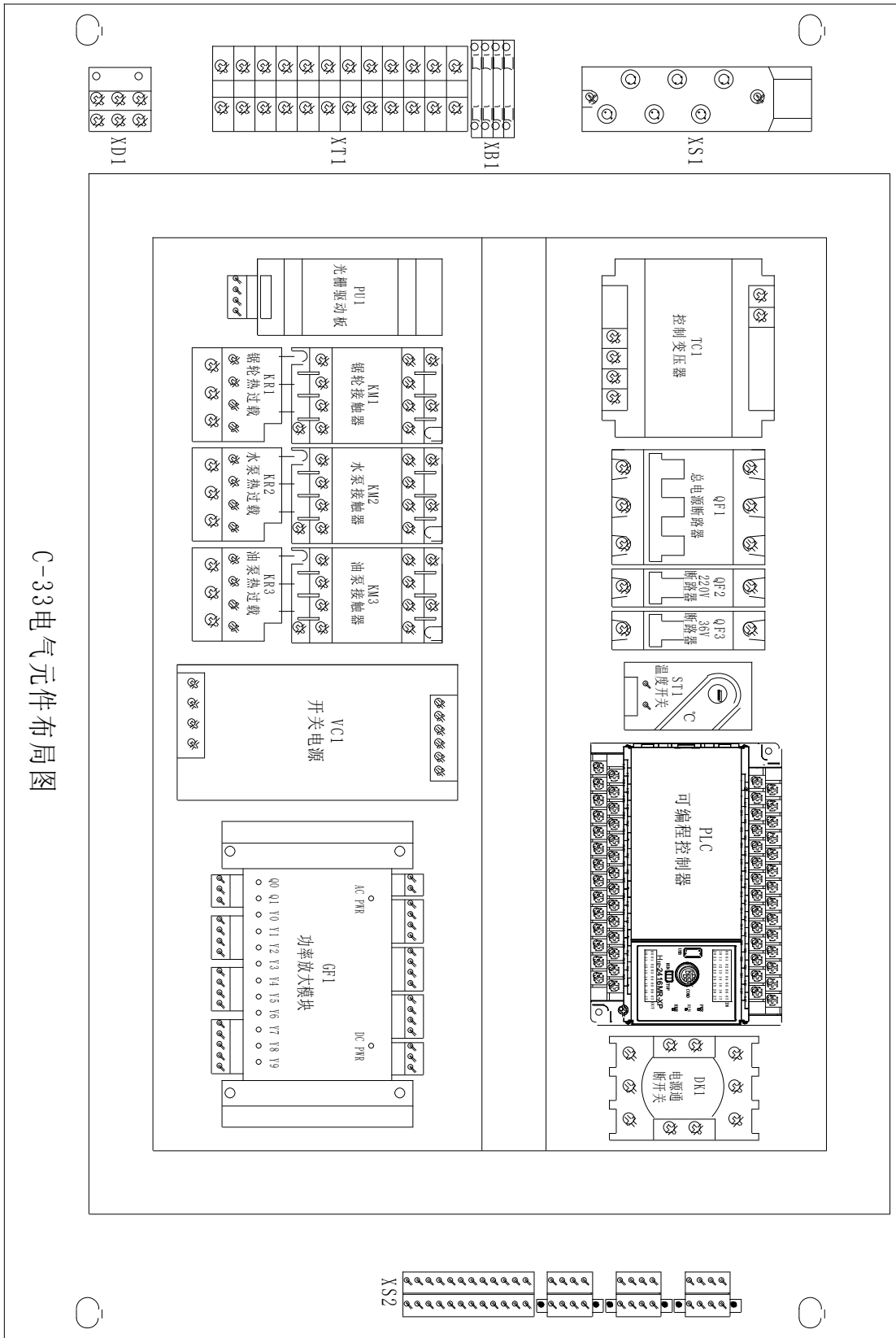

C-33电气元件布局图

# 7、 Main Unit

## 7.3.2 回路

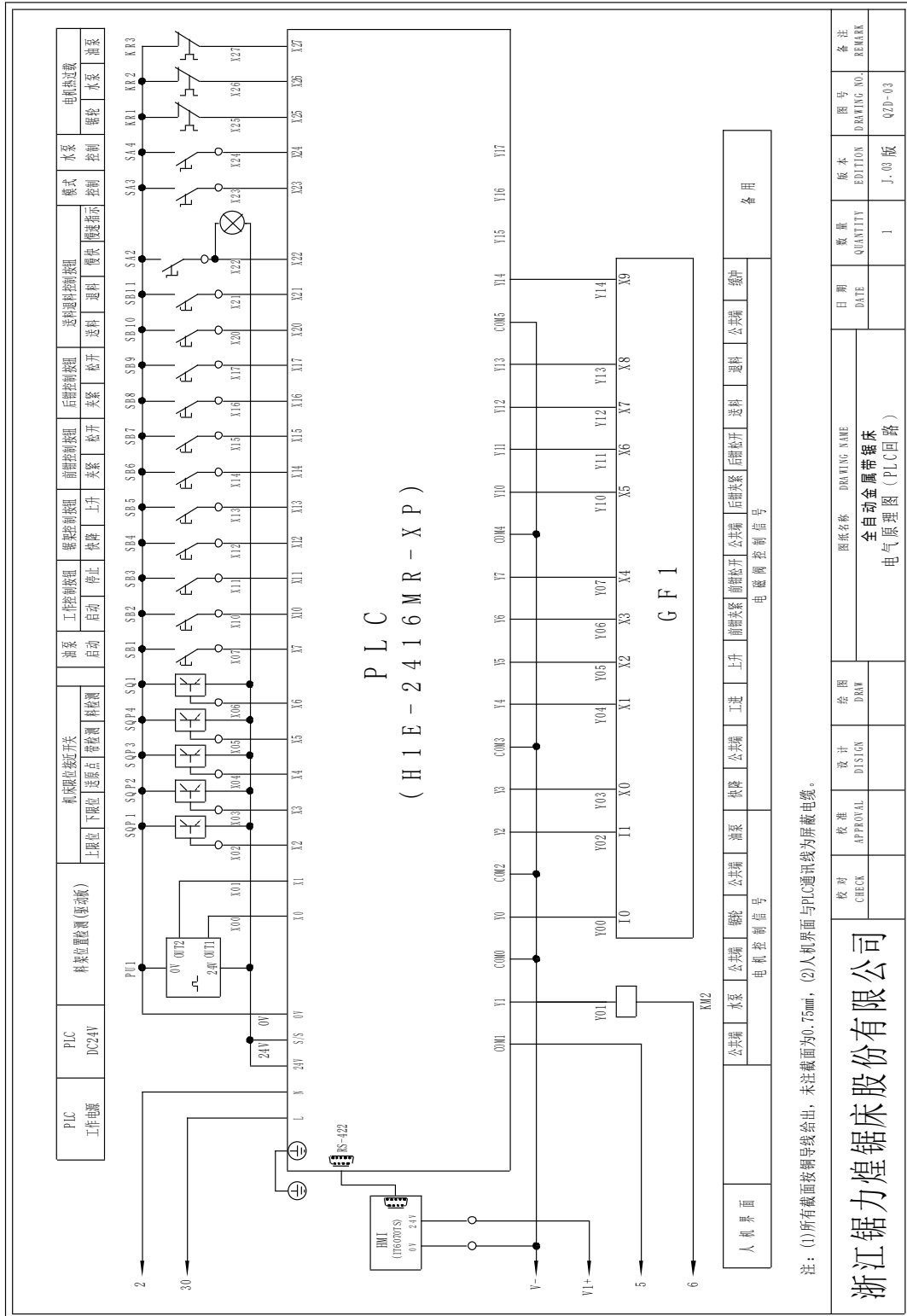

浙江锯力煌锯床股份有限公司

---

## 8.1 troubleshooting

Touch screen fault and troubleshooting strategy

NO	fault	strategy
1	Touch the start and stop buttons of the oil pump, and the machine does not respond (" communication connection "indicator does not blink)	<ul style="list-style-type: none"><li>◆ the communication cable on the back of the touch screen is loosened, reinserted and tightened by hand.</li><li>◆ ◆ the PLC PWR or RUN indicator light in the electric box is not on, please refer to the PLC manual for troubleshooting.</li><li>◆ Touch screen body has fault, return to the factory for maintenance</li></ul>
2	Boot screen display normal, unable to switch to other interface	<ul style="list-style-type: none"><li>◆ touch panel has damage, return to the factory for maintenance.</li><li>◆ Touch panel failure, return to factory for repair.</li></ul>
3	Power on black screen, no display	<ul style="list-style-type: none"><li>◆ the power plug on the back of the touch screen is loose, plug it in and press tight.</li><li>◆ the switch power indicator light in the electric box is not on, please refer to the switch power manual for troubleshooting.</li><li>◆ Touch screen body has fault, return to the factory for maintenance.</li></ul>



Please carefully read the instructions in the "matters needing attention" section and effectively execute it. Please pay attention to the daily cleaning and maintenance of the touch screen, which can greatly reduce the probability of failure of the touch screen!